

LOGISTICS- SOLUTIONS for special DEMANDS

WWW.HMH.EU



Stay on top of things



external dimension
w x l x h in mm



internal dimension
w x l x h in mm



load capacity
in kg



body



material of the base
(plastic / wood / steel)

colour selection

The base made of plastic is available in different colours. Please choose one of the colours from the list below and replace the corresponding digits in the item number of your order.

Ex.: In the item number KB2A**5010**1350CS01101 „**5010**“ stands for gentian blue. For a different colour please insert one of the below listed colour codes at this place .

	5010	gentian blue
	5012	light blue
	6024	traffic green
	3000	flame red
	7032	peddle grey
	7046	telegrey
	7046 + „H“	telegrey hygiene (Ex.: KB2A 7046 1350CS01101 H)
	9005	black
	9005 + „R“	recycling base black (Ex.: KB2A 9005 1350CS01101 R)

Do not hesitate to contact us

+49 2952 - 970958-80



ABOUT US

Home of Material Handling. The home of intralogistics.

Where experience, technical expertise and a clear understanding of processes come together, concepts are developed that make workflows more efficient and prove their worth in day-to-day operations. This is exactly what **HMH Holding GmbH** stands for.

As a **manufacturer and full-service provider of logistics equipment**, we develop solutions that are more than just standard products. Our transport solutions integrate seamlessly into our customers' workflows. With well-designed products and reliable implementation, we make processes more efficient, safer and more cost-effective.

Under our registered own brands **rolltainer®**, **nestainer®**, **rolldolly®**, **gummitex®** and **tainergrip®**, we offer a comprehensive range of **roll containers**, **transport trolleys** and **logistics systems** made from metal, plastic and wood. This results in solutions for industry, retail, distribution and many other areas of application that prove their worth in practice.

The product range is complemented by a versatile **range of accessories** as well as further intralogistics solutions such as **mesh stacking frames**, **insulated containers**, **plastic containers**, **plastic pallets** and **electric tugger trains**. Dimensions, features and design can be tailored precisely to your requirements.

Our extensive product range, our many years of experience and a clear commitment to collaboration form the basis for successful and trusting business relationships. What sets us apart is our technical expertise and our collaborative approach.

We listen. We think proactively. And we deliver.

That is precisely what makes HMH the home of intralogistics.

Learn more on
www.hmh.eu



- 4** **rolltainer®**
The allrounder
- 48** **nestainer®**
The compact ones
- 62** **Steel roll containers**
The solid ones
- 84** **Laundry containers**
The tidy ones
- 106** **rolldolly®**
The helpers
- 126** **Cargo systems**
The strong ones
- 150** **Special applications**
The creative ones
- 162** **Wheels and castors**
The dynamic ones
- 172** **Accessories**
The improver

rolltainer®



4

rolltainer®

The possible applications of rolltainer® are almost unlimited: from transport to order picking to the storage of your products, there are no limits. Whether plastic, wooden or steel base – we offer a variety of options for our rolltainer®. Combine those with different intermediate shelves and numerous accessories and create the rolltainer® for your needs.

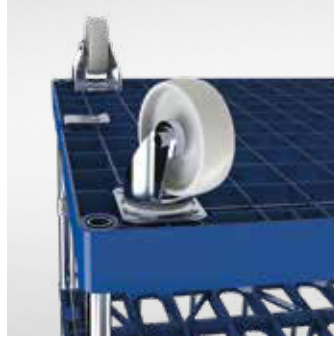

huge range of
**WHEELS
AND
CASTORS**
162



Choose the
**MATERIAL
AND COLOUR**
of your base
8

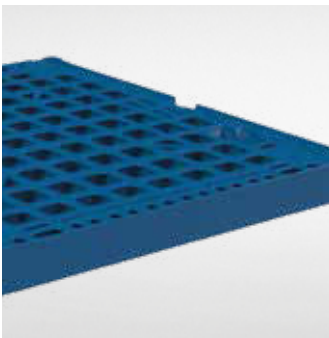

high amount of
**ACCESSORIES
FOR INDIVIDUAL
NEEDS**
172

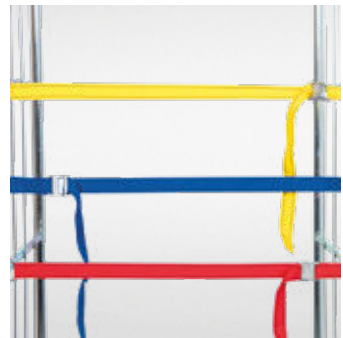

NEW



**OPTIMAL COMPACTION
OF EMPTIES 5:1**



ROLLTAINER 2-SIDED



WITH INSERTED
SIDE PANELS

rolltainer®

5 ROLLTAINER AT ONE STORAGE SPACE

 724 x 815 mm

 500 kg





 2-sided

 plastic

rolltainer® with plug-in system

- plastic base made of high-quality HDPE-material
- plastic base with innovative plug-in system, 4 side panels can be inserted in the middle, another 4 side panels can be placed in between
- 4 plastic bases are placed left and right of the adjusted side panels
- with two swivel and two fixed castors, \varnothing 108 mm, wheel center / tread: polypropylene
- three different usable heights 1350, 1450 and 1650 mm
- side panel made of \varnothing 22 mm round tube, infill made of 12 x 3 mm flat bars and a centered tube \varnothing 16 mm
- surface: galvanized blue Cr 3

rolltainer® 2-sided with plug-in system

	rolltainer® 2-sided with plug-in system		
	 724 x 815 x 1.530 mm  660 x 815 x 1.340 mm	 724 x 815 x 1.630 mm  660 x 815 x 1.440 mm	 724 x 815 x 1.830 mm  660 x 815 x 1.640 mm
rolltainer® with plug-in system	KB2A50101350CS01101V	KB2A50101450CS02101V	KB2A50101650CS14101V

6



- fast, systematic compaction of empties
- high work safety due to fixed slots for 4 side panels
- sustainable storage and transportation of empties
- The new base is a 100% compatible with existing components – there is no need for new side panels. Side panels with T-clamp are ideal. Please contact us for detailed advice!

- It is also possible to solely store side panels.
- In comparison to the classic compaction of empties, each storage space can be utilized up to 150% more.



watch the product video

Scan the QR Code and view the assembling.

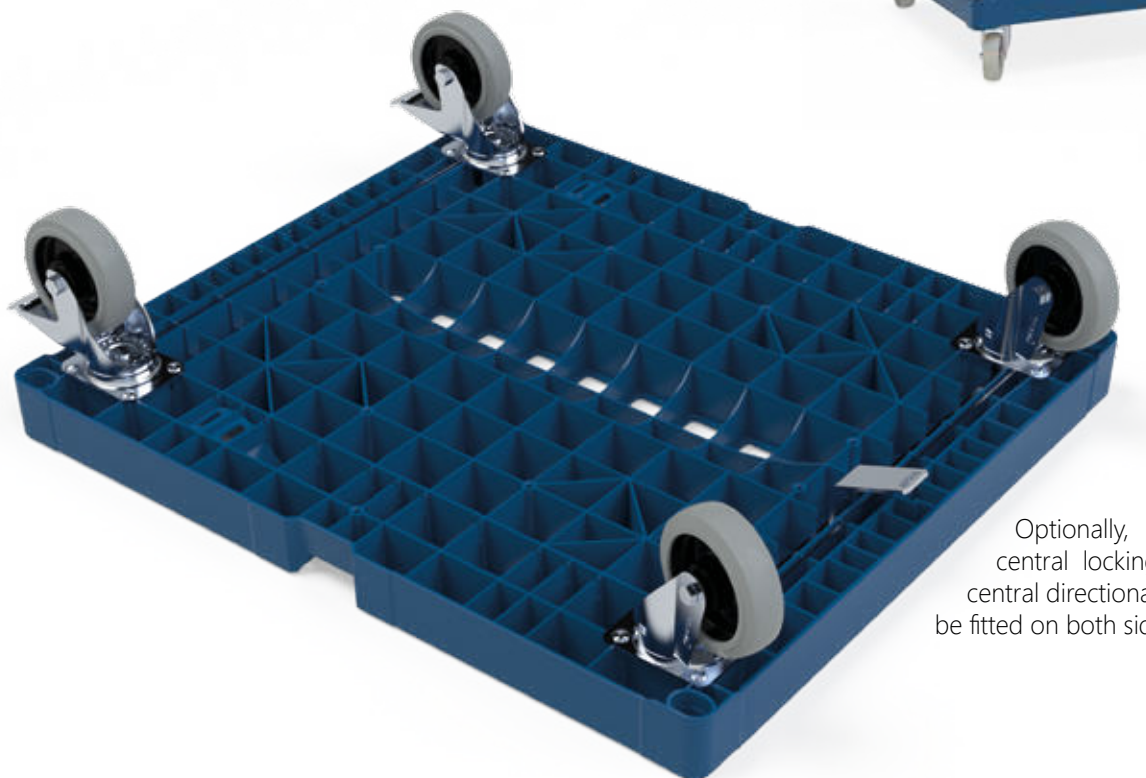

Optionally, swivel castors with central locking system and / or central directional locking device can be fitted on both sides.

The right base for each requirement

The bases build the basis for our rolltainer®. The range includes different plastic bases, as well as bases made of wood or steel. Plastic bases are available in different colours. In addition, those bases made of plastic can be embossed with lettering and a logo.

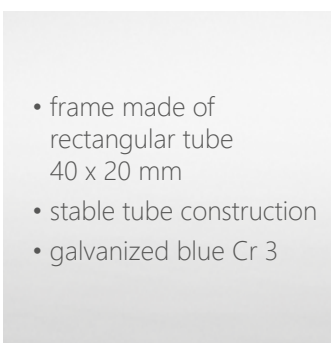
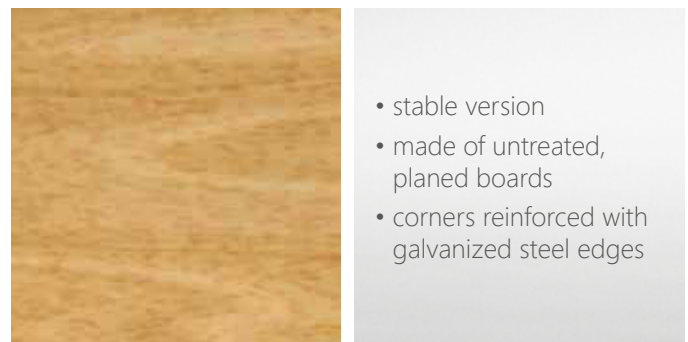
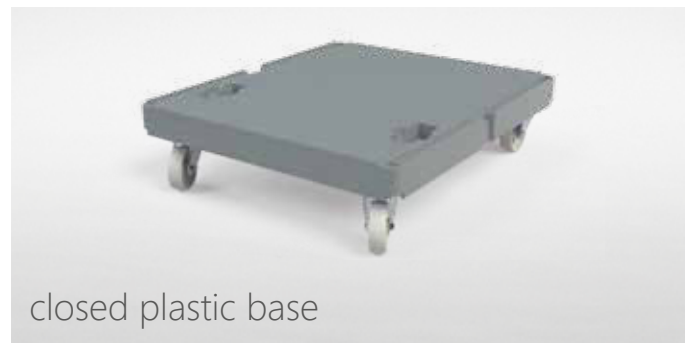
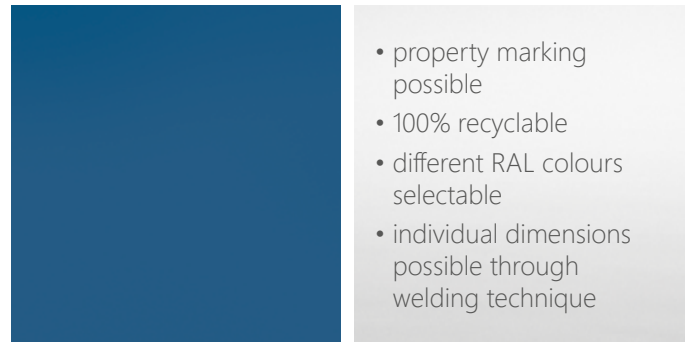

Our wide range of colours

The base made of plastic is available in different colours. Please replace the corresponding colour code at the marked position of the item number when ordering. In item number „KB2A**5010**1350CS01101“, „**5010**“ stands for gentian blue.

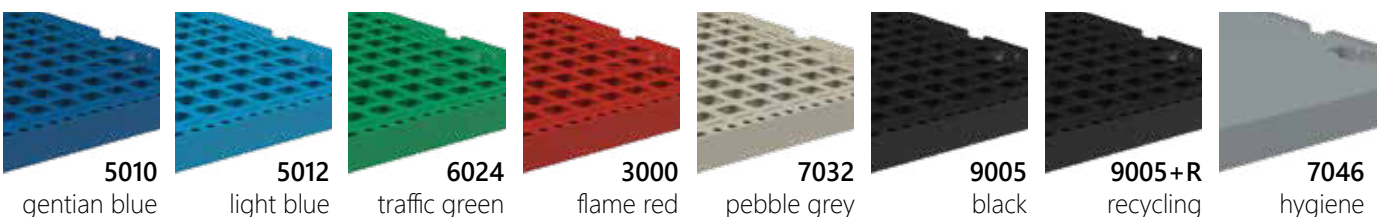



RANGE OF CASTORS STARTING AT PAGE 162

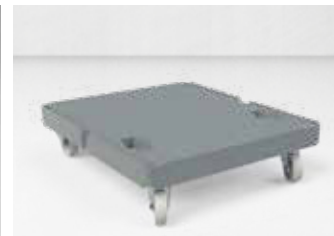

PLASTIC BASE WITH CLOSED
LOADING PLATFORM



WOODEN BASE



METAL BASE

PLASTIC BASE
IN 5010 GENTIAN BLUE

 724 x 815 mm

 500 kg

 plastic / wood / steel

Base 724 x 815 mm

- choose between plastic base made of high-quality HDPE-material, wooden base or steel base
- with two swivel and two fixed castors, \varnothing 108 mm, wheel center / tread: polypropylene
- four insertion holes for round tube \varnothing 22 mm (\varnothing 25 mm possible on request)
- optionally strengthened with two or four flat bars

	Base  724 x 815 mm
plastic*	E10A00PE4 5010 OL-001
plastic closed	F15A00PE270460L-001
wood	HRP724810N-001
steel	MRP710800C-001

* The base made of plastic is available in different colours. You can find the corresponding colour code on the cover of our catalogue. (Ex.: In item number „KB2A**5010**1350CS01101“, „**5010**“ stands for gentian blue.).





INDIVIDUAL LABELING

of your rolldolly®, rolltainer® and plastic shelf

If you have decided to buy a **rolldolly®**, **rolltainer®** or **intermediate shelves made of plastic**, we can label those components individually for you by using hot stamping. The hot stamping is generally applied to the front sides. Only the rolldolly® additionally can be marked on the long sides. For your lettering you can choose between the colours white, black, red, yellow or blue. The decision whether to take a standard lettering out of our „letter plug-in system“ or taking an individualized lettering with your own font and maybe also your logo, is yours.



ALL BENEFITS AT A GLANCE

- ✓ letters available in three sizes 12 mm, 25 mm (standard size) and 35 mm
- ✓ stamps are made of brass
- ✓ individual stamps with the company logo possible
- ✓ huge range of prefabricated popular elements available, e.g. „property“
- ✓ print area up to 470 x 40 mm possible



The plug-in system consists of capital letters in three different sizes. The lettering can be supplemented with special characters and additions like „property“. We are happy to advise you on the specific options.

If you wish to have a stamp with your own font and / or your logo, we produce a stamp made of brass for you. You provide your lettering / logo as a template for us. The stamp can be used for subsequent orders and will be stored properly for you after using.



With our newly developed laser technology, we are able to laser barcodes and QR codes in all common symbologies onto the roll base and intermediate shelves made of HDPE.

We use modern fibre laser technology for this. This is a high-precision marking and labelling system that uses a very fine laser beam to permanently laser QR codes, barcodes, logos and labels onto the surface of the plastic bases. This happens contactlessly in seconds and without consumables such as ink or labels. With this laser technology, we achieve durable, UV- and chemical-resistant marking of your roll bases, ensuring perfect traceability and quality assurance for your products.



**LETTERS AVAILABLE IN
THREE SIZES:
12 MM, 25 MM AND 35 MM**



**UNIVERSALLY
USABLE**

12



3-SIDED

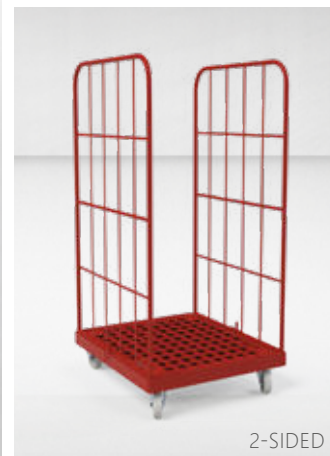

2-SIDED

rolltainer®

2-SIDED
WITH PLASTIC SHELF
(AVAILABLE AS ACCESSORIES)

724 x 815 mm

500 kg

2- / 3-sided

plastic

rolltainer® 1350 / 1450 QP

- plastic base made of high-quality HDPE-material
- with two swivel and two fixed castors, \varnothing 108 mm, wheel center / tread: polypropylene
- side panel made of \varnothing 22 mm round tube, infill made of 12 x 3 mm flat bars and a centered tube \varnothing 16 mm
- back wall made of \varnothing 22 mm round tube and four holes to attach it to the side panels by using plastic clamps
- surface: powder coated according to RAL-colours

	rolltainer® 1350 QP 724 x 815 x 1.530 mm		rolltainer® 1450 QP 724 x 815 x 1.630 mm	
	2-sided 660 x 815 x 1.340 mm	3-sided 660 x 775 x 1.340 mm	2-sided 660 x 815 x 1.440 mm	3-sided 660 x 775 x 1.440 mm
blue	KB2A501013505010S01101	KB3A501013505010S01101	KB2A501014505010S02101	KB3A501014505010S02101
green	KB2A602413506024S01101	KB3A602413506024S01101	KB2A602414506024S02101	KB3A602414506024S02101
red	KB2A300013503000S01101	KB3A300013503000S01101	KB2A300014503000S02101	KB3A300014503000S02101

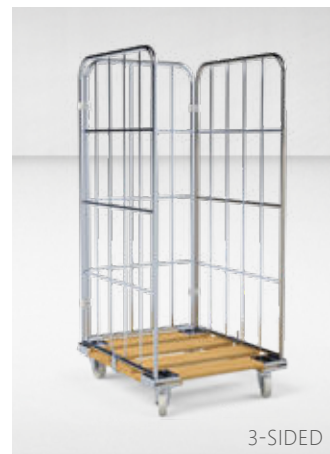

3-SIDED



4-SIDED

2-SIDED

 724 x 815 mm

 500 kg

 2- / 3- / 4-sided

 plastic / wood / steel

rolltainer® 1350 / 1450 / 1650

- three different usable heights, optionally available in 2-, 3- or 4-sided
- choose between plastic base made of high-quality HDPE-material, wooden base or steel base
- with two swivel and two fixed castors, \varnothing 108 mm, wheel center / tread: polypropylene
- side panels, back wall and front wall made of \varnothing 22 mm round tube, infill made of 12 x 3 mm flat bars
- side panel with horizontal, centered tube \varnothing 16 mm
- surface: galvanized blue, Cr 3

ALL BENEFITS AT A GLANCE



MORE STABILITY THROUGH CENTERED TUBE



LONG-LASTING DUE TO GALVANIZED SURFACE



IDEAL CONNECTION BETWEEN SIDE PANEL AND BASE



T-CLAMP FOR FAST DISASSEMBLING

14



rolltainer® 1350 724 x 815 x 1.530 mm			
	2-sided 660 x 815 x 1.340 mm	3-sided 660 x 775 x 1.340 mm	4-sided 660 x 750 x 1340 mm
plastic*	KB2A 5010 1350CS01101	KB3A 5010 1350CS01101	KB4A 5010 1350CS01101
plastic base with closed loading platform	KB2A70461350CS01101H	KB3A70461350CS01101H	KB4A70461350CS01101H
wood	HB2AN1350CS01101	HB3AN1350CS01101	HB4AN1350CS01101
steel	MB2AC1350CS01101	MB3AC1350CS01101	MB4AC1350CS01101

rolltainer® 1450 724 x 815 x 1.630 mm			
	2-sided 660 x 815 x 1.440 mm	3-sided 660 x 775 x 1.440 mm	4-sided 660 x 750 x 1440 mm
plastic*	KB2A 5010 1450CS02101	KB3A 5010 1450CS02101	KB4A 5010 1450CS02101
plastic base with closed loading platform	KB2A70461450CS02101H	KB3A70461450CS02101H	KB4A70461450CS02101H
wood	HB2AN1450CS02101	HB3AN1450CS02101	HB4AN1450CS02101
steel	MB2AC1450CS02101	MB3AC1450CS02101	MB4AC1450CS02101

rolltainer® 1650 724 x 815 x 1.830 mm			
	2-sided 660 x 815 x 1.640 mm	3-sided 660 x 775 x 1.640 mm	4-sided 660 x 750 x 1.640 mm
plastic*	KB2A 5010 1650CS14101	KB3A 5010 1650CS14101	KB4A 5010 1650CS14101
plastic base with closed loading platform	KB2A70461650CS14101H	KB3A70461650CS14101H	KB4A70461650CS14101H
wood	HB2AN1650CS14101	HB3AN1650CS14101	HB4AN1650CS14101
steel	MB2AC1650CS14101	MB3AC1650CS14101	MB4AC1650CS14101

* The base made of plastic is available in different colours. You can find the corresponding colour code on the cover of our catalogue. (Ex.: In item number „KB2A**5010**1350CS01101“, „**5010**“ stands for gentian blue.)

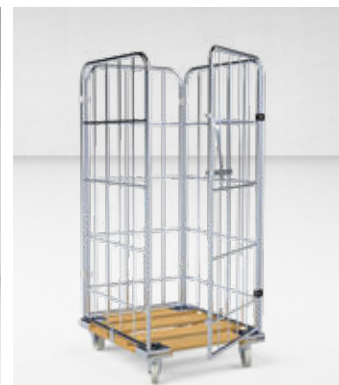

4-SIDED WITH SINGLE-SECTION FRONT WALL



4-SIDED WITH FOLDABLE AND PIVOTABLE FRONT WALL

3-SIDED

rolltainer[®]

724 x 815 x 1.640 mm
 500 kg
 2- / 3- / 4-sided
 plastic / wood / steel

rolltainer[®] 1460 FV

- front wall optionally available pivotable in one piece or foldable and pivotable
- choose between plastic base made of high-quality HDPE-material, wooden base or steel base
- with two swivel and two fixed castors, ø 108 mm, wheel center / tread: polypropylene
- side panels, back wall and front wall made of ø 22 mm round tube, infill made of 12 x 3 mm flat bars
- surface: galvanized blue, Cr 3

	rolltainer [®] 1460 FV 724 x 815 x 1.640 mm			
	2-sided	3-sided	4-sided with front wall foldable and pivotable	4-sided with front wall pivotable in one piece
	660 x 815 x 1.450 mm	660 x 775 x 1.450 mm	660 x 750 x 1.450 mm	660 x 750 x 1.450 mm
plastic*	KB2A 5010 1460CS03101	KB3A 5010 1460CS03101	KB4A 5010 1460CS03101	KB4A 5010 1460CS03301
plastic base with closed loading platform	KB2A70461460CS03101H	KB3A70461460CS03101H	KB4A70461460CS03101H	KB4A70461460CS03301H
wood	HB2AN1460CS03101	HB3AN1460CS03101	HB4AN1460CS03101	HB4AN1460CS03301
steel	MB2AC1460CS03101	MB3AC1460CS03101	MB4AC1460CS03101	MB4AC1460CS03301

* The base made of plastic is available in different colours. You can find the corresponding colour code on the cover of our catalogue. (Ex.: In item number „KB2A**5010**1350CS01101“, „**5010**“ stands for gentian blue.)



WITH THREE DIFFERENT VERSIONS OF THE FRONT WALL



4-SIDED WITH FOLDABLE AND PIVOTABLE FRONT WALL

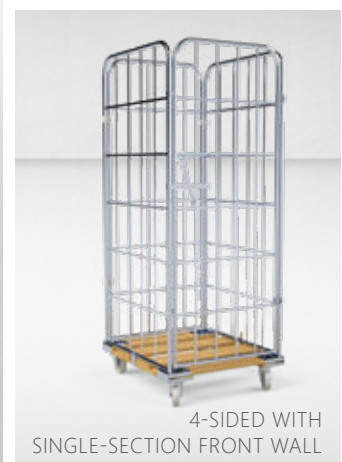

4-SIDED WITH SINGLE-SECTION FRONT WALL

rolltainer®

4-SIDED WITH TWO INDIVIDUALLY PIVOTABLE FRONT WALLS

724 x 815 x 1.830 mm
500 kg
2- / 3- / 4-sided
plastic / wood / steel

rolltainer® 1650 FV

- front wall optionally available pivotable in one piece, pivotable in two parts or foldable and pivotable
- choose between plastic base made of high-quality HDPE-material, wooden base or steel base
- with two swivel and two fixed castors, ø 108 mm, wheel center / tread: polypropylene
- side panels, back wall and front wall made of ø 22 mm round tube; infill made of 12 x 3 mm flat bars
- surface: galvanized blue, Cr 3

rolltainer® 1650 FV 724 x 815 x 1.830 mm					
	2-sided 660 x 815 x 1.640 mm	3-sided 660 x 775 x 1.640 mm	4-sided with foldable and pivotable front wall 660 x 750 x 1.640 mm	4-sided with front wall pivotable in two pieces 660 x 750 x 1.640 mm	4-sided with front wall pivotable in one piece 660 x 750 x 1.640 mm
plastic*	KB2A50101650CS04101	KB3A50101650CS04101	KB4A50101650CS04101	KB4A50101650CS04201	KB4A50101650CS04301
closed loading platform	KB2A70461650CS04101H	KB3A70461650CS04101H	KB4A70461650CS04101H	KB4A70461650CS04201H	KB4A70461650CS04301H
wood	HB2AN1650CS04101	HB3AN1650CS04101	HB4AN1650CS04101	HB4AN1650CS04201	HB4AN1650CS04301
steel	MB2AC1650CS04101	MB3AC1650CS04101	MB4AC1650CS04101	MB4AC1650CS04201	MB4AC1650CS04301

* The base made of plastic is available in different colours. You can find the corresponding colour code on the cover of our catalogue. (Ex.: In item number „KB2A50101350CS01101“, „5010“ stands for gentian blue.)



**20° INCLINATION
OF THE INTER-
MEDIATE SHELVES
FORWARDS OR BACK-
WARDS POSSIBLE**



ROLL SHELF WITH 20° INCLINATION



ROLL SHELF WITHOUT INCLINATION



ROLL SHELF WITH 20° INCLINATION AND SIX INTERMEDIATE SHELVES (AVAILABLE AS ACCESSORIES)

rolltainer®

 815 x 724 x 1.790 mm
  500 kg
  3-sided
  plastic / wood / steel

rolltainer® rollshelf 1600

- in contrast to the standard, the structure is open on a long side
- 20° inclination of the horizontal flat bars can be selected to fall forwards or backwards (delivery also possible without inclination)
- choose between plastic base made of high-quality HDPE-material, wooden base or steel base
- with two swivel castors and two swivel castors with total brake, ø 108 mm, wheel center / tread: polypropylene
- side panels and back wall made of ø 22 mm round tube; infill made of 12 x 3 mm flat bars
- surface: galvanized blue, Cr 3

	rolltainer® rollshelf  815 x 724 x 1.790 mm	
	3-sided incl. 3 intermediate shelves with 20° inclination  750 x 680 x 1.600 mm	3-sided incl. 3 intermediate shelves without inclination  750 x 680 x 1.600 mm
plastic*	KRR3A50101600C104	KRR3A50101600C204
wood	HRR3AN1600C104	HRR3AN1600C204
steel	MRR3AC1600C104	MRR3AC1600C204
additional shelf	ZBD810RRMRC01	



* The base made of plastic is available in different colours. You can find the corresponding colour code on the cover of our catalogue. (Ex.: In item number „KB2A50101350CS01101“, „5010“ stands for gentian blue.)

COMFORT THROUGH SAFETY: tainergrip®

A short moment of abstraction and the hand gets caught between two roll cages. A painful experience which often results in absence of personnel.



From now on these incidents belong to the past.

The tainergrip® is an ergonomically shaped handgrip made of special

plastic, created to prevent hand injuries. The safety handle can be attached to the rolltainer® quickly and easily without using any tools. The ideal protection for all sectors in which rolltainer® play a decisive role.

TECHNICAL HIGHLIGHTS

dimension:
total ca. 215 x 100 x 80 mm
grip ca. 150 x 75 x ø 18 mm

basic holder for round tube: ø 22 mm
and square tube: 22 x 22 mm

tainergrip orange for flat bars:
12 x 3 and 15 x 3 mm
tainergrip red for tube:
ø 16 mm

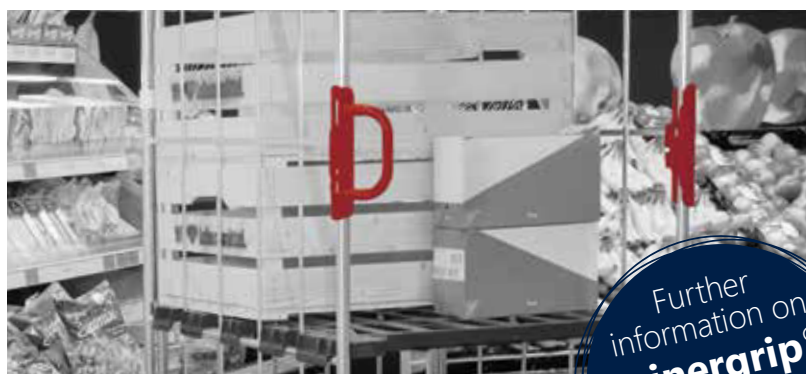

Further information on **tainergrip®** available on **PAGE 180**

high quality through strengthened special plastic

innovative prevention of accidents

comfortable and easy handling through ergonomic design



innovative system for more safety at work

ergonomically shaped and safe in use



PERFECT
THEFT PROTECTION

rolltainer®

5-SIDED
WITH PLASTIC BASE



3-SIDED
WITH STEEL BASE

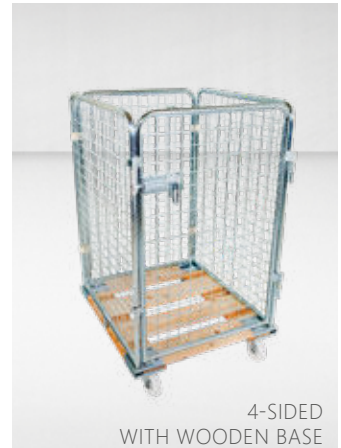

4-SIDED
WITH WOODEN BASE

724 x 815 mm

500 kg

3- / 4- / 5-sided

plastic / wood / steel

rolltainer® ADB 1020

- convenient and space-saving height
- choose between plastic base made of high-quality HDPE-material, wooden base or steel base
- with two swivel and two fixed castors, ø 108 mm, wheel center / tread: polypropylene
- side panels, back wall, door and roof made of ø 22 mm round tube with mesh 50 x 50 x 4 mm
- surface: galvanized blue, Cr 3

rolltainer® ADB 1020			
	724 x 815 x 1.210 mm	724 x 815 x 1.220 mm	
	3-sided 660 x 775 x 1.020 mm	4-sided 660 x 750 x 1.020 mm	5-sided 660 x 750 x 995 mm
plastic*	KAD3A50101020COZ101	KAD4A50101020COZ101	KAD5A50101020COZ101
plastic base with closed loading platform	KAD3A70461020COZ101H	KAD4A70461020COZ101H	KAD5A70461020COZ101H
wood	HAD3AN1020COZ101	HAD4AN1020COZ101	HAD5AN1020COZ101
steel	MAD3AC1020COZ101	MAD4AC1020COZ101	MAD5AC1020COZ101

* The base made of plastic is available in different colours. You can find the corresponding colour code on the cover of our catalogue. (Ex.: In item number „KB2A50101350CS01101“, „5010“ stands for gentian blue.)

20

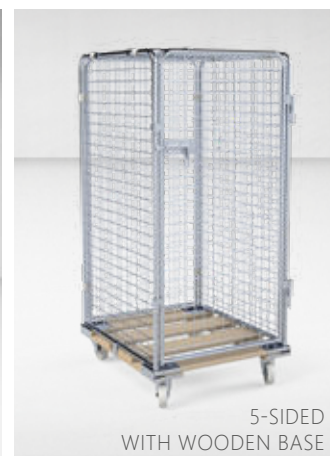
5-SIDED
WITH WOODEN BASE4-SIDED
WITH STEEL BASE

rolltainer®

3-SIDED
WITH PLASTIC BASE

724 x 815 mm

500 kg

3- / 4- / 5-sided

plastic / wood / steel

rolltainer® ADB 1350

- choose between plastic base made of high-quality HDPE-material, wooden base or steel base
- with two swivel and two fixed castors, \varnothing 108 mm, wheel center / tread: polypropylene
- side panels, back wall, door and roof made of \varnothing 22 mm round tube with mesh 50 x 50 x 4 mm
- surface: galvanized blue, Cr 3

rolltainer® ADB 1350			
	724 x 815 x 1.540 mm		724 x 815 x 1.550 mm
	3-sided 660 x 775 x 1.350 mm	4-sided 660 x 750 x 1.350 mm	5-sided 660 x 750 x 1.325 mm
plastic*	KAD3A50101350COZ101	KAD4A50101350COZ101	KAD5A50101350COZ101
plastic base with closed loading platform	KAD3A70461350COZ101H	KAD4A70461350COZ101H	KAD5A70461350COZ101H
wood	HAD3AN1350COZ101	HAD4AN1350COZ101	HAD5AN1350COZ101
steel	MAD3AC1350COZ101	MAD4AC1350COZ101	MAD5AC1350COZ101

* The base made of plastic is available in different colours. You can find the corresponding colour code on the cover of our catalogue. (Ex.: In item number „KB2A50101350CS01101“, „5010“ stands for gentian blue.)

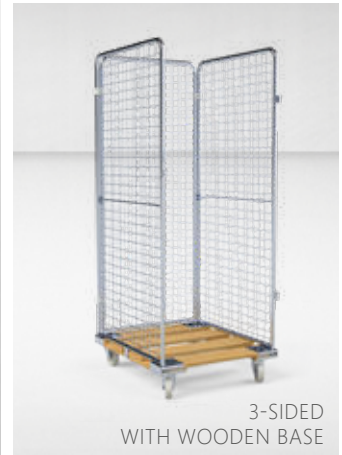

rolltainer®

724 x 815 mm

500 kg

3- / 4- / 5-sided

plastic / wood / steel

rolltainer® ADB 1600

- large storage space for your products
- flexible arrangement of the intermediate shelves possible every 50 mm
- choose between plastic base made of high-quality HDPE-material, wooden base or steel base
- with two swivel and two fixed castors, ø 108 mm, wheel center / tread: polypropylene
- side panels, back wall, door and roof made of ø 22 mm round tube with mesh 50 x 50 x 4 mm
- surface: galvanized blue, Cr 3

rolltainer® ADB 1600			
724 x 815 x 1.800 mm			
	3-sided 660 x 775 x 1.610 mm	4-sided 660 x 750 x 1.610 mm	5-sided 660 x 750 x 1.585 mm
plastic*	KAD3A 5010 1600COZ101	KAD4A 5010 1600COZ101	KAD5A 5010 1600COZ101
plastic base with closed loading platform	KAD3A70461600COZ101H	KAD4A70461600COZ101H	KAD5A70461600COZ101H
wood	HAD3AN1600COZ101	HAD4AN1600COZ101	HAD5AN1600COZ101
steel	MAD3AC1600COZ101	MAD4AC1600COZ101	MAD5AC1600COZ101

* The base made of plastic is available in different colours. You can find the corresponding colour code on the cover of our catalogue. (Ex.: In item number „KB2A**5010**1350CS01101“, „**5010**“ stands for gentian blue.)





724 x 815 mm | 500 kg | 5-sided | plastic / wood / steel

rolltainer® ADB 1600 with foldable intermediate shelf

- foldable intermediate shelf insertable approx. in the middle of the **rolltainer®**
- optionally available with a two-section or a single-section door

	rolltainer® ADB 1600 724 x 815 x 1.800 mm	
	5-sided with a single-section door and a foldable intermediate shelf 660 x 750 x 1.585 mm	5-sided with a two-section door and a foldable intermediate shelf 660 x 750 x 1.585 mm
plastic*	KAD5A 5010 1600C1Z101	KAD5A 5010 1600C1Z201
plastic base with closed loading platform	KAD5A70461600C1Z101H	KAD5A70461600C1Z201H
wood	HAD5AN1600C1Z101	HAD5AN1600C1Z201
steel	MAD5AC1600C1Z101	MAD5AC1600C1Z201
wire shelf loose version	ZBD725ADLC004	
plastic shelf loose version	F73F05PEF37046	

* The base made of plastic is available in different colours. You can find the corresponding colour code on the cover of our catalogue. (Ex.: In item number „KB2A**5010**1350CS01101“, „**5010**“ stands for gentian blue.)



rolltainer[®]

4-SIDED

4-SIDED WITH FOLDABLE INTERMEDIATE SHELF

724 x 815 mm

500 kg

4-sided

plastic / wood / steel

rolltainer[®] ADB 1600 „the disposer“

- choose between plastic base made of high-quality HDPE-material, wooden base or steel base
- with two swivel castors with total brake and two fixed castors, ø 108 mm, wheel center / tread: polypropylene
- side panels, back wall and two single doors made of ø 22 mm round tube with mesh 50 x 50 x 4 mm
- surface: galvanized blue, Cr 3

	rolltainer [®] ADB 1600 without intermediate shelf 724 x 815 x 1.800 mm 660 x 750 x 1.585 mm	rolltainer [®] ADB 1600 with intermediate shelf 724 x 815 x 1.800 mm 660 x 750 x 1.585 mm
plastic*	KAD4A 5010 1600COZ602	KAD4A 5010 1600C1Z602
plastic base with closed loading platform	KAD4A 5010 1600COZ602	KAD4A 5010 1600C1Z602
wood	HAD4AN1600COZ602	HAD4AN1600C1Z602
steel	MAD4AC1600COZ602	MAD4AC1600C1Z602

* The base made of plastic is available in different colours. You can find the corresponding colour code on the cover of our catalogue. (Ex.: In item number „KB2A**5010**1350CS01101“, „**5010**“ stands for gentian blue.)



WITH ASSEMBLED COVER

ADB 1600 OPAQUE SOLUTION WITH AND WITHOUT INTERMEDIATE SHELF



rolltainer® ADB 1410 5-SIDED SUITABLE FOR E1/E2-BOXES



rolltainer® ADB 1460 4-SIDED

rolltainer®

724 x 815 mm 500 kg 5-sided plastic / wood / steel

rolltainer® ADB special applications

- special container in different usable heights and designs for various applications, like waste disposal and visual cover transports
- choose between plastic base made of high-quality HDPE-material, wooden base or steel base
- with two swivel and two fixed castors, ø 108 mm, wheel center / tread: polypropylene
- side panels, back wall, door and roof made of ø 22 mm round tube with mesh 50 x 50 x 4 mm
- surface: galvanized blue, Cr 3

	rolltainer® with visual cover 5-sided 724 x 815 x 1.800 mm 660 x 750 x 1.585 mm	rolltainer® with visual cover 5-sided with shelf 724 x 815 x 1.800 mm 660 x 750 x 1.585 mm
plastic*	KAD5A 5010 1600COZ901	KAD5A 5010 1600C1Z901
	rolltainer® ADB 1410 5-sided with single-section door 724 x 850 x 1.590 mm 660 x 815 x 1.375 mm	rolltainer® ADB 1460 4-sided with foldable and pivotable door 724 x 815 x 1.640 mm 660 x 750 x 1.450 mm
plastic*	KAD5A 5010 1410COZ301	KAD4A 5010 1460COZ302
plastic base with closed loading platform	KAD5A70461410COZ301H	KAD4A70461460COZ302H
wood	HAD5AN1410COZ301	HAD4AN1460COZ302
steel	MAD5AC1410COZ301	MAD4AC1460COZ302

* The base made of plastic is available in different colours. You can find the corresponding colour code on the cover of our catalogue. (Ex.: In item number „KB2A**5010**1350CS01101“, „**5010**“ stands for gentian blue.)

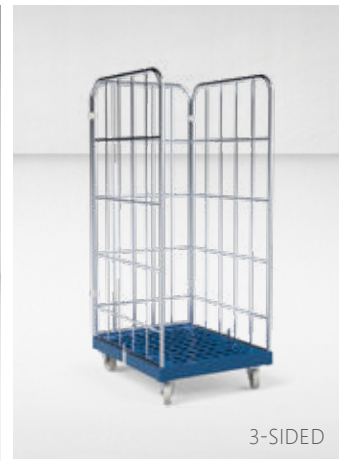

3-SIDED

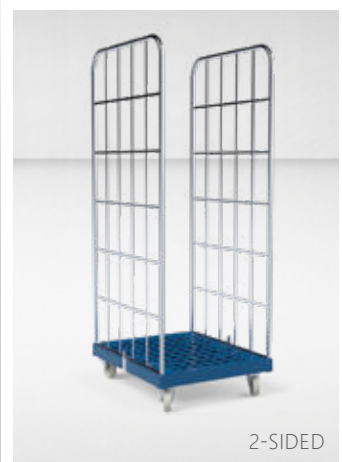

2-SIDED

rolltainer[®]

3-SIDED WITH ADDITIONAL INTERMEDIATE SHELF (AVAILABLE AS ACCESSORIES)

682 x 815 mm
500 kg
2- / 3-sided
plastic

rolltainer[®] 682 1460 / 1650

- ideal transport solution for Euronorm boxes, through the internal dimension of 620 x 810 mm
- in the case of the 3-sided structure, the back wall is mounted on the outside, so that the interior offers full space for Euronorm boxes
- plastic base made of high-quality HDPE-material
- with two swivel and two fixed castors, ø 108 mm, wheel center / tread: polypropylene
- side panels and back wall made of ø 22 mm round tube, infill made of 12 x 3 mm flat bars
- surface: galvanized blue, Cr 3

	rolltainer [®] 682 1460		rolltainer [®] 682 1650	
	2-sided	3-sided	2-sided	3-sided
	682 x 815 x 1.640 mm 620 x 815 x 1.450 mm	682 x 835 x 1.640 mm 620 x 815 x 1.450 mm	682 x 815 x 1.830 mm 620 x 815 x 1.640 mm	682 x 835 x 1.830 mm 620 x 815 x 1.640 mm
plastic gentian blue (similar to RAL 5010)	KB2B50101460CS03101	KB3B50101460CS03101	KB2B50101650CS04101	KB3B50101650CS04101
plastic flame red (similar to RAL 3000)	KB2B30001460CS03101	KB3B30001460CS03101	KB2B30001650CS04101	KB3B30001650CS04101
plastic base gentian blue	E10B10PE45010OL-001			
plastic base flame red	E10B10PE43000OL-001			



682 x 815 x 1.608 mm

500 kg

2-sided

plastic

rolltainer® 682 1350

- each side panel with three support rails made of flat steel, especially for Euronorm boxes
- plastic base made of high-quality HDPE-material
- with two swivel and two fixed castors, \varnothing 125 mm, wheel center / tread: polyamide / polyurethane
- side panels made of \varnothing 22 mm round tube, connection of the side panels made of flat steel
- surface: galvanized blue, Cr 3



	rolltainer® 682 1350
	620 x 815 x 1320 mm
plastic gentian blue (similar to RAL 5010)	KB3B50101350CS0111
plastic flame red (similar to RAL 3000)	KB3B30001350CS0111



3-SIDED



4-SIDED

rolltainer®

5-SIDED

682 x 870 x 1.800 mm

500 kg

3- / 4- / 5-sided

plastic

rolltainer® 682 ADB 1600

- an anti-theft container on a 682 mm wide plastic base provides maximum security for your goods and is optimized for Euronorm boxes
- flexible arrangement of the intermediate shelves possible every 50 mm
- plastic base made of high-quality HDPE-material
- with two swivel and two fixed castors, ø 108 mm, wheel center / tread: polypropylene
- side panels, back wall, door and roof made of ø 22 mm round tube with mesh 50 x 50 x 4 mm
- surface: galvanized blue, Cr 3

	rolltainer® 682 ADB 1600 682 x 870 x 1.800 mm		
	3-sided 620 x 825 x 1.610 mm	4-sided 620 x 825 x 1.610 mm	5-sided 620 x 825 x 1.585 mm
plastic gentian blue (similar to RAL 5010)	KAD3B50101600COZ101	KAD4B50101600COZ101	KAD5B50101600COZ101
plastic flame red (similar to RAL 3000)	KAD3B30001600COZ101	KAD4B30001600COZ101	KAD5B30001600COZ101
intermediate shelf	ZBD682ADLC008		





rolltainer®

4-SIDED WITH FOLDABLE FRONT WALL

682 x 815 x 1.690 mm
 500 kg
 2- / 3- / 4-sided
 plastic

rolltainer® 682 1500 FH

- plastic base made of high-quality HDPE-material
- with two swivel and two fixed castors, ø 108 mm, wheel center / tread: polypropylene
- easy assembling of front and back wall
- side panel made of ø 19 mm round tube
- surface: hot-dipped (for ideal corrosion protection)



rolltainer® 682 1500 FH 682 x 815 x 1.690 mm			
	2-sided 620 x 815 x 1.495 mm	3-sided 620 x 770 x 1.495 mm	4-sided 620 x 735 x 1.495 mm
plastic*	KB2B50101500HDS00101	KB3B50101500HDS00101	KB4B50101500HDS00101

rolltainer® 1500 675 x 815 x 1.690 mm 2-sided 610 x 815 x 1.440 mm	
plastic*	KB2D50101500HDS00101

* The base made of plastic is available in different colours. You can find the corresponding colour code on the cover of our catalogue. (Ex.: In item number „KB2A50101350CS01101“, „5010“ stands for gentian blue.)

NEW

**IDEAL FOR
EURONORM BOXES**

rolltainer®

3-SIDED
WITH EURONORM BOXES

E16 PLASTIC BASE

3-SIDED,
SIDE PANELS GALVANIZED BLUE

 675 x 815 mm









 500 kg

 2- / 3-sided

 plastic

rolltainer® 682 1460 / 1650

- ideal transport solution for Euronorm boxes
- plastic base made of high-quality HDPE-material
- basic model with 2 side panels, different panel versions available
- in the case of the 3-sided structure, the back wall is mounted on the outside, so that the interior offers full space for Euronorm boxes
- with two swivel and two fixed castors, ø 108 mm, wheel center / tread: polypropylene
- side panels made of ø 22 mm round tube, infill made of 12 x 3 mm flat bars
- surface: galvanized blue, Cr 3

	rolltainer® 675 1460		rolltainer® 675 1650	
	2-sided  675 x 815 x 1.640 mm  610 x 815 x 1.450 mm	3-sided  675 x 835 x 1.640 mm  610 x 815 x 1.450 mm	2-sided  675 x 815 x 1.830 mm  610 x 815 x 1.640 mm	3-sided  675 x 835 x 1.830 mm  610 x 815 x 1.640 mm
plastic gentian blue (similar RAL 5010)	KB2D50101460CS03101	KB3D50101460CS03101	KB2D50101650CS04101	KB3D50101650CS04101
plastic flame red (similar RAL 3000)	KB2D30001460CS03101	KB3D30001460CS03101	KB2D30001650CS04101	KB3D30001650CS04101
plastic base gentian blue	E16D00PE45010OL-001			
plastic base flame red	E16D00PE43000OL-001			

30

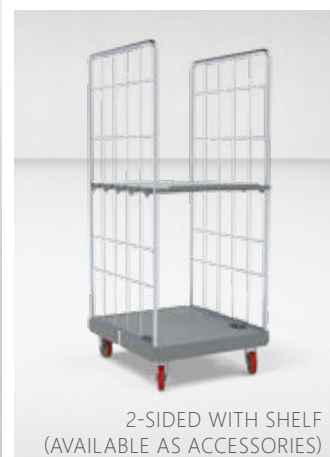

HYGIENIC PLASTIC BASE

2-SIDED WITH SHELF
(AVAILABLE AS ACCESSORIES)3-SIDED WITH
INTERMEDIATE SHELF
(AVAILABLE AS ACCESSORIES)

rolltainer®

724 x 815 x 1.783 mm

500 kg

2- / 3-sided

plastic

rolltainer® hygienic stainless steel

- plastic base made of high-quality HDPE-material, top and bottom closed and welded, except for the stacking hole, colour: telegrey similar to RAL 7046
- with two swivel and two fixed castors, \varnothing 125 mm, wheel center / tread: polyamide / polyurethane, housing and roller bearing of the castors are made of stainless steel
- side panel made of \varnothing 22 mm round tube, infill made of \varnothing 6 mm wire rods
- material: stainless steel „V2A“

	rolltainer® hygienic stainless steel 724 x 815 x 1.750 mm	
	2-sided 660 x 815 x 1.520 mm	3-sided 660 x 775 x 1.520 mm
rolltainer® hygiene	KB2A70461530A2S241I3	KB3A70461530A2S241I3
hygienic plastic base	F12A00PE07046OL-0I3	
hygienic intermediate shelf	F71A02PEF37046E	F71A03PEF37046E



rolltainer®

2-SIDED WITH BASKET AND SEPARATION GRIDS



LOGISTIC ROLLBOX



724 x 815 mm

500 kg

2- / 5-sided

plastic

rolltainer® Special

rolltainer® plastic 724 x 815 x 1.655 mm

- incl. a stabilization frame ø 22 mm
- plastic base made of high-quality HDPE-material
- with two swivel and two fixed castors, ø 125 mm, wheel center / tread: polyamide / polyurethane
- side panel made of ø 22 mm round tube with mesh 100 x 50 x 4 mm, each with an angulated handle made of round tube
- surface: galvanized blue, Cr 3

logistic rollbox 1589 KU grey

- rolltainer clad with twin-wall sheets
- plastic base made of high-quality HDPE-material, pebble grey similar to RAL 7032
- with two swivel and two fixed castors, ø 108 mm, wheel center / tread: polypropylene,
- side panels, back wall, roof and lockable door made of ø 22 mm round tube
- surface: powder coated gentian blue similar to RAL 5010

	rolltainer® special
rolltainer® plastic* 724 x 815 x 1.655 mm	KB3A 5010 1450CS57111
basket ME 724 x 815 mm	DK720C01
separation grid ME for basket ME	TG720C01
logistic rollbox 1589 KU 724 x 815 x 1.770 mm, 5-sided	KB5A703215895002101



BASKET WITH SEPARATION GRID

* The base made of plastic is available in different colours. You can find the corresponding colour code on the cover of our catalogue. (Ex.: In item number „KB2A**5010**1350CS01101“, „**5010**“ stands for gentian blue.).



WITH FOLDABLE
PUSH HANDLE

FOLDABLE GALVANIZED PUSH HANDLE



FOLDED PUSH HANDLE



WOODEN BASE WITH
GALVANIZED PUSH HANDLE



STEEL BASE WITH
GALVANIZED PUSH HANDLE

 724 x 815 mm

 300 kg / 500 kg

 plastic / wood / steel

Base with push handle

- choose between plastic base made of high-quality HDPE-material, wooden base or steel base
- load capacity: 300 kg / 500 kg
- push handle made of \varnothing 22 mm steel tube
- height of the handle ca. 1.000 mm
- protrusion of the push handle ca. 374 mm
- foldable push handle, galvanized blue, Cr 3



	base with push handle  660 x 815 mm	
	\varnothing 100 TPR castors (2 swivel and 2 fixed castors) load capacity: 300 kg	\varnothing 125 PU castors (2 swivel and 2 fixed castors) load capacity: 500 kg
plastic* with galvanized push handle	KB1A 5010 815CB00125	KB1A 5010 815CB001G5
wood with galvanized push handle	HB1AN815CB00125	HB1AN815CB001G5
steel with galvanized push handle	MB1AC815CB00125	MB1AC815CB001G5

* The base made of plastic is available in different colours. You can find the corresponding colour code on the cover of our catalogue. (Ex.: In item number „KB2A**5010**1350CS01101“, „**5010**“ stands for gentian blue.)



 500 kg
  plastic

Plastic base special

- three additional sizes for your demand
- plastic base made of high-quality HDPE-material
- panels and accessories for these bases must be requested separately

plastic base special 780 x 790 mm

- strengthend with four flat bars
- with two swivel and two fixed castors, \varnothing 125 mm, big plate (hole pattern 105 x 80 mm), wheel center / tread: polypropylene

plastic base special 695 x 815 mm

- strengthend with four flat bars
- with two swivel and two fixed castors, \varnothing 100 mm, big plate (hole pattern 105 x 80 mm), wheel center / tread: polyamide

	plastic base special
plastic base 780 x 790 mm	F13E00PE45012FE-0E1
plastic base 695 x 815 mm	F11C00PE43000OL-0K4

NEW



rolltainer®

4-SIDED WITH
2-SECTION FRONT WALL,
INDIVIDUALLY PIVOTABLE



2-SECTION FRONT WALL,
INDIVIDUALLY PIVOTABLE



CABINET BOLT



1.200 x 780 x 1.805 mm



500 kg



4-sided



plastic

rolltainer® 1590 KU

- plastic base made of high-quality HDPE material
- with two swivel and two fixed castors, \varnothing 108 mm, wheel center / tread: polypropylene
- side panels, back wall and front wall made of \varnothing 22 mm round tube with mesh 80 x 80 x 5 mm
- surface: galvanized blue, Cr 3

rolltainer® 1590 KU |  1.200 x 780 x 1.805 mm

4-sided

 1.126 x 718 x 1.590 mm

rolltainer® 1490 KU

KAD4C70461590COZ501

CORNER PROTECTION

MADE OF STEEL

Our revolutionary corner protection for bases not only reduces the cases of damage by up to 90%, but also makes it possible to still use the rolltainer® even with a broken corner. The corner protection is made of steel and is attached to the base through four screws. Even with a heavy load the handling is still easy, as the forces apportion among the steel corner protections. There is no longer pressure on to the plastic corners

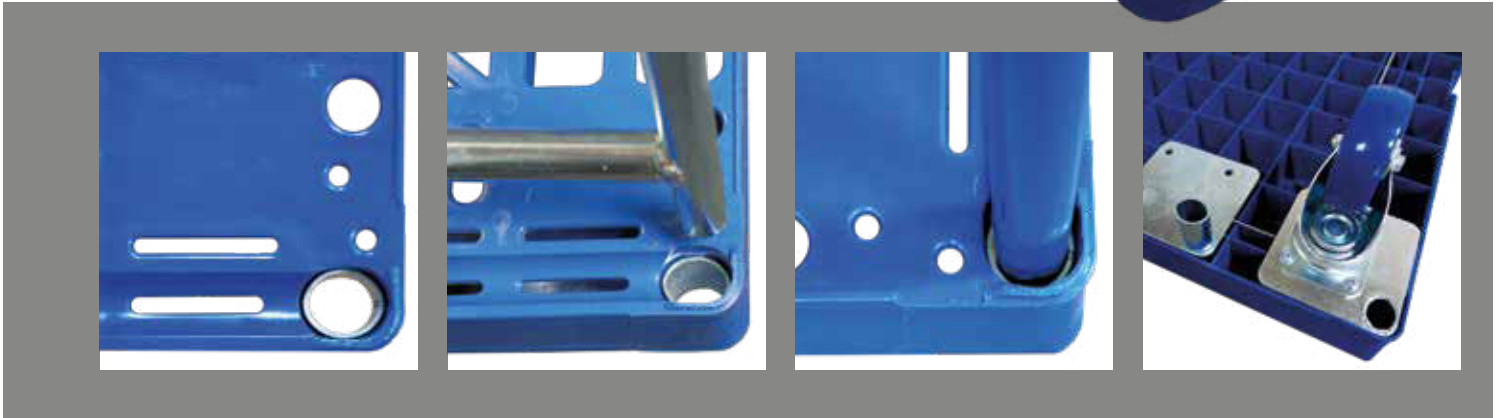

quick and easy stacking of the base

still usable with a broken corner

better handling even with heavy loads

RAL colours at buyer's option

available for the bases with 682 mm and 724 mm width

up to 90% less cases of damage

hot stamping of the front side

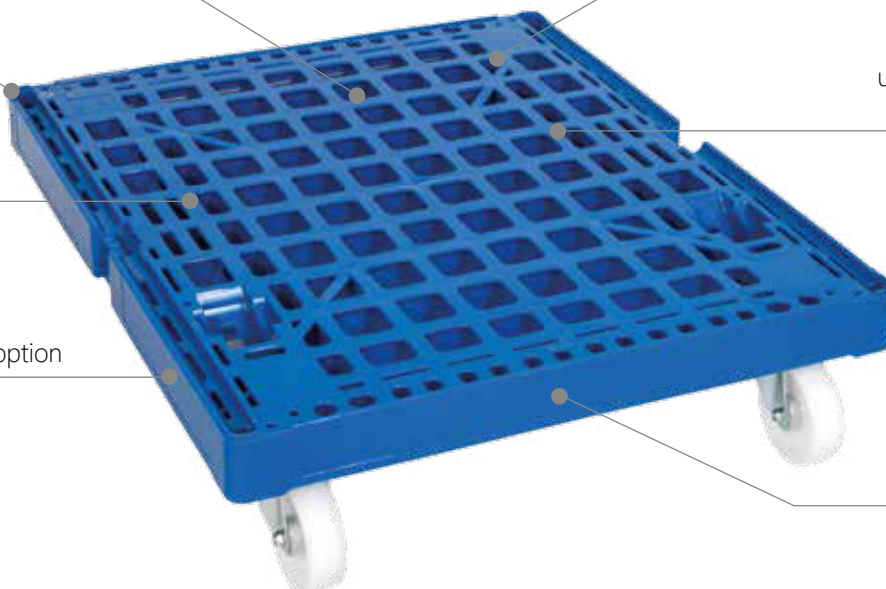

NEW



ROLLTAINER WITH DOUBLE CLAMP



SIDE PANEL WITH TWO CLAMPING BRACKETS



ROLL BASE 724

724 x 815 mm

500 kg

4-sided

plastic

rolltainer® with double clamp

Optionally, the plastic base can be manufactured with two additional clamping areas. This allows for the use of side panels with one or two clamping brackets. Side panels with two clamping brackets provide a stronger connection to the roll base on its long side.

The plastic roll base and side panels are manufactured order-related. Various side panels with powder coating or galvanization are available. The plastic roll base can be manufactured in the colour of your choice and with hot stamping. It is also possible to fit the four corners with metal corner protectors.

We would be happy to advise you on the available options.

rolltainer®

nestainer®

Steel roll containers

Laundry containers

rolldolly®

Cargo systems

Special applications

Wheels and castors

Accessories

Accessories shelves



Plastic intermediate shelf for rolltainer® 724 x 815 mm

- made of high-quality HDPE-material
- strengthened with three flat bars made of galvanized steel
- load capacity: 150 kg

2-sided | 710 x 810 mm

F70A02PEF35010

2- and 3-sided | 710 x 778 mm

E70A23PEF35010

4-sided | 710 x 735 mm

E70A04PEF35010



Plastic intermediate shelf for rolltainer® 682 x 815 mm

- made of high-quality HDPE-material
- strengthened with three flat bars made of galvanized steel
- load capacity: 150 kg

2-sided | 670 x 810 mm

E70B02PEF35010

3-sided | 670 x 770 mm

E70B03PEF35010

4-sided | 670 x 730 mm

E70B04PEF35010



Plastic intermediate shelf half length for rolltainer® 724 x 815 mm

- made of high-quality HDPE-material
- strengthened with two flat bars made of galvanized steel
- load capacity: 100 kg

2-/3-/4-sided | 710 x 380 mm

E70H23PEF25010

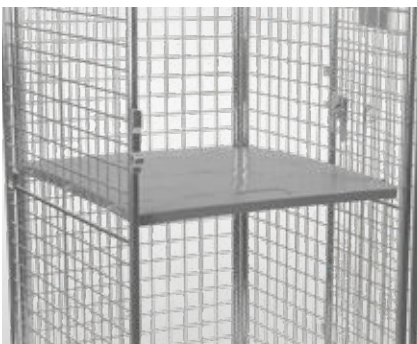

Intermediate shelf ADB closed, 724 x 815 mm

- plastic shelf with closed loading platform made of high-quality HDPE-material, telegrey similar to RAL 7046
- strengthened with three flat bars steel made of galvanized steel
- load capacity: 150 kg

2-/3-/4-sided | 705 x 728 mm | telegrey

F73F05PEF37046

* The base made of plastic is available in different colours. You can find the corresponding colour code on the cover of our catalogue. (Ex.: In item number „F70A02PEF35010“, „5010“ stands for gentian blue.)

An assignment
of the suitable
**INTERMEDIATE
SHELVES**
can be found on
PAGE 186



Closed plastic intermediate shelf for rolltainer® 724 x 815 mm

- with closed loading platform made of high-quality HDPE-material
- telegrey similar to RAL 7046
- strengthened with three flat bars made of galvanized steel
- load capacity: 150 kg

2-sided 710 x 812 mm telegrey	F71A02PEF37046
3-sided 710 x 762 mm telegrey	F71A03PEF37046



Hygienic intermediate shelf KU for rolltainer® 724 x 815 mm

- with closed loading platform made of high-quality HDPE-material
- telegrey similar to RAL 7046
- strengthened with three flat bars made of **stainless steel**
- load capacity: 150 kg

2-sided 710 x 812 mm telegrey	F71A02PEF37046E
3-sided 710 x 762 mm telegrey	F71A03PEF37046E



Wire mesh intermediate shelf for rolltainer®

- wire mesh shelf strengthened with flat bars
- without anti-slip edge
- variably attachable
- surface: galvanized blue, Cr 3

2-/3-/4-sided 700 x 705 mm	ZBD725ADLC004
2-/3-/4-sided 680 x 810 mm	ZBD682ADLC008



Wooden intermediate shelf for rolltainer® 724 x 815 mm

- strengthened with two pipes made of square tube 20 x 20 mm
- load capacity: 150 kg
- loading platform made of untreated plywood panel

2-/3-/4-sided 700 x 720 mm	ZBH660710F2
------------------------------	-------------

rolltainer® WITH COMFORT SYSTEM

Our rolltainer® with comfort system is characterized by the innovative quick-coupling-system of the side panels and the easy handling: With the counterpressure during assembly, the side panels trigger the mechanism and are immediately ready for use.

The mechanism can easily be loosened with one foot and the side panels can be removed. The rolltainer® with comfort system offers the user a high level of flexibility due to the short time required for dismantling.

TECHNICAL HIGHLIGHTS

- plastic base made of high impact strength PP-material, signal grey similar to RAL 7004
- with two swivel and two fixed castors, ø 108 mm, wheel center / tread: polyamide
- two side panels made of ø 22 mm round tube, infill made of four vertical flat bars 12 x 3 mm and four horizontal round tubes ø 16 mm
- surface: galvanized blue, Cr 3



2-SIDED WITH
TWO INTERMEDIATE SHELVES

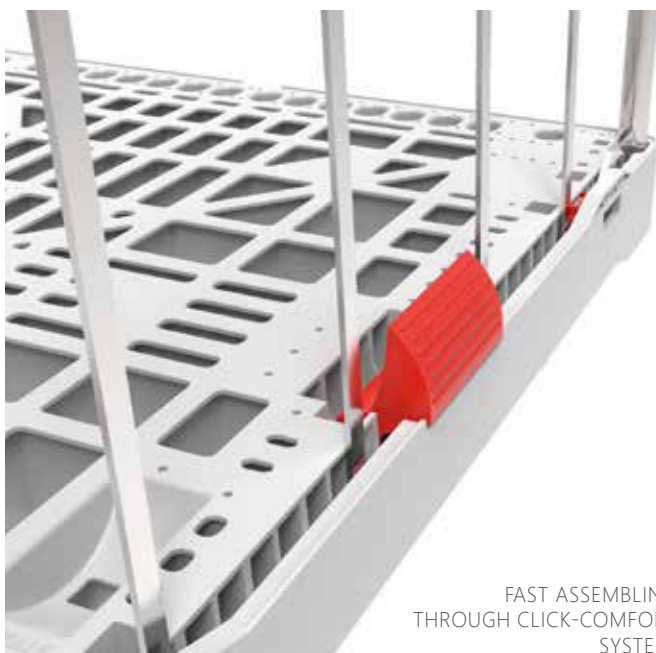

FAST ASSEMBLING
THROUGH CLICK-COMFORT
SYSTEM.

The insertable intermediate shelves do not only permit a flexible, horizontal division of the rolltainer, but also a conversion to a universal container with back wall. This greatly increases the field of application of our rolltainer.

rolltainer® with comfort system	
plastic	KB2A70041725CS09156
intermediate shelf	W70A02PPF57004

UP TO 22 INTERMEDIATE
SHELVES FIT INTO
ONE ROLLTAINER®.

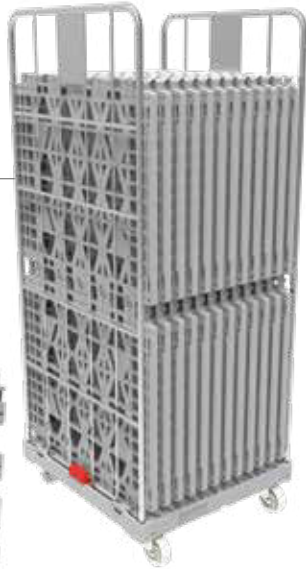

In addition, the rolltainer® with comfort system offers a lot of space: 16 side panels or 22 intermediate shelves can easily be stowed away into one rolltainer® to save space. A quick volume reduction (76 %) is achieved thanks to the integrated slots for the castors in the base with which the bases can be stacked.

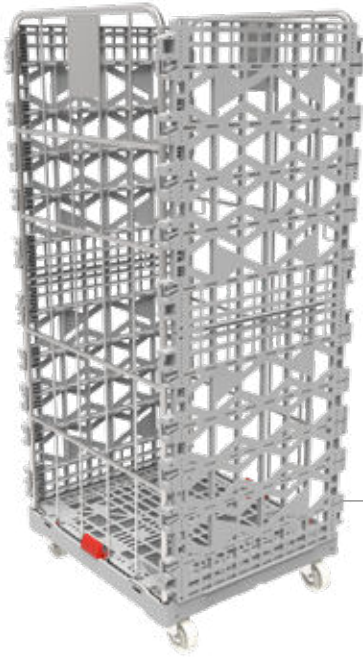

THE INTERMEDIATE
SHELVES CAN BE USED
AS BACK WALL.

FOR MORE INFORMATION
WATCH OUR
PRODUCT VIDEO

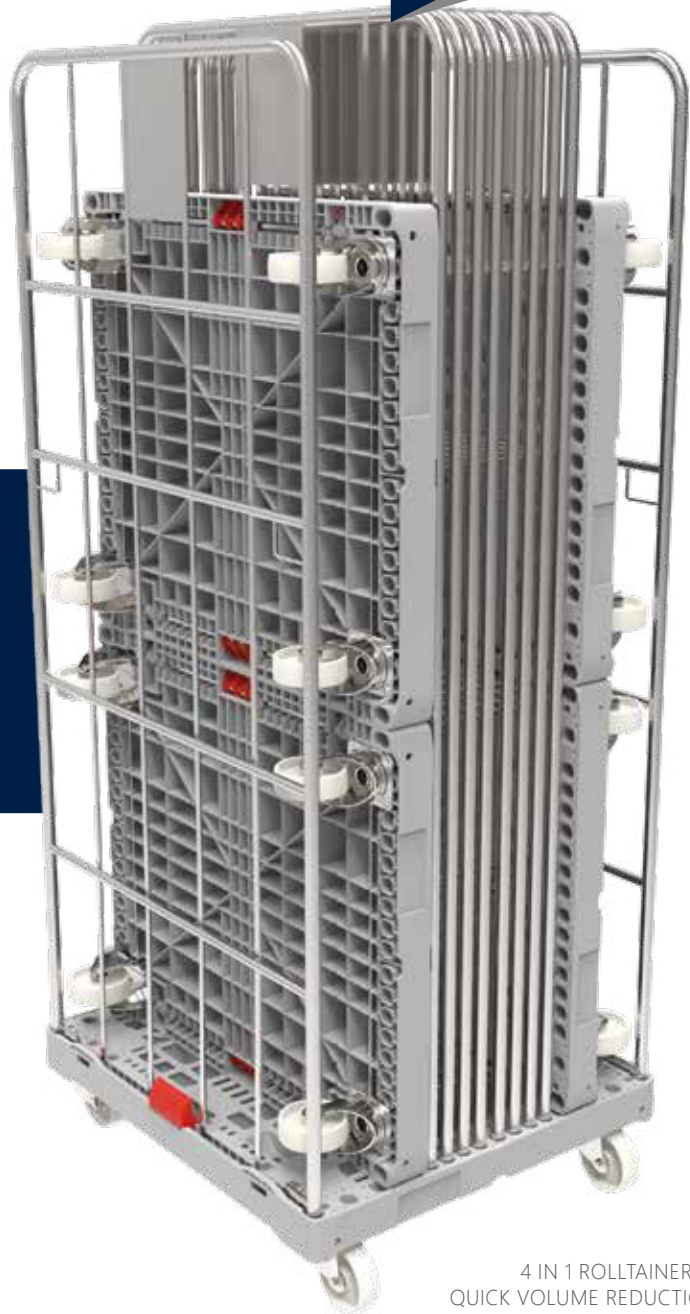

TECHNICAL DATA

 720 x 810 x 1.840 mm

 660 x 810 x 1.655 mm

 2-sided  500 kg  plastic



UP TO 16 SIDE PANELS



UP TO 19 BASES

4 IN 1 ROLLTAINER® –
QUICK VOLUME REDUCTION



SUSTAINABILITY IS A TOP PRIORITY

What is sustainable and really good for our environment? For us, it starts already with the manufacturing of high-quality new products. A durable product stands the test of time in practice and is going to be a valuable resource in the recycling process. We can already possess several years' expe-

rience in terms of the recycling of plastic bases. In the beginning we only used old products manufactured by our own. The results were highly convincing so that we expanded the process onto third-party products, by now.



STEEL

The flat bars used for strengthening the bases are dismantled. Galvanized steel can be recycled, so that the amount of recycled material is up to 70 %.

PLASTIC BASES

From dismantled bases we gain granules which we use for the production of new bases. With this process we can save between 2,4 kg and 4,2 kg CO₂ depending on the base.



CASTORS

Castors of HMH have, depending on the stress, a service life of up to 10 years. Based on defined condition criteria, we check if dismantled castors can be reused.



**»What we do today,
will determine
what the world
looks like tomorrow.«**

Marie of Ebner-Eschenbach

FOR THIS WE TAKE THE FOLLOWING STEPS:

- collection of the bases sorted out by the customer (usually including the castors)
- transfer to the factory
- disassembly and at the same time checking and assorting of the castors and flat bars
- plastic bases are shredded, afterwards the coarse material is elaborately cleaned and re-granulated
- the re-granulated plastic is used in the production process of bases, intermediate shelves and rolldollies
- The new products made of re-granule can be directly redelivered to the initial customer. In this case, the former used castors and flat bars can be reused with an amount of up to 70%.
- Each customer has the chance to buy specially marked products made of re-granule from us. If we use a re-granule out of different colours, the new produced products are black.
- With each recycled base we can save between 2,4 kg and 4,2 kg CO².



plastic
made of
recycling
material

BASIC
line
just good



rolltainer®

low
self-weight
enables parcel
shipment

rolltainer® BASIC

- **dimensions 2-sided up to 500 kg load capacity:**
724 x 815 x 1.530 mm / interior: 664 x 815 x 1.340 mm
- **dimensions 3-sided up to 500 kg load capacity:**
724 x 827 x 1.530 mm / interior: 664 x 803 x 1.340 mm
- **dimensions 4-sided with a single-section door up to 500 kg load capacity:**
724 x 845 x 1.530 mm / interior: 664 x 803 x 1.340 mm
- **dimensions 4-sided with a two-section door up to 500 kg load capacity:**
724 x 845 x 1.530 mm / interior: 664 x 801 x 1.340 mm
- plastic base made of recycling material
- with two swivel and two fixed castors ø 108 mm, wheel center / tread: polypropylene
- side panel, back wall and door made of ø 20 x 1.5 mm all around tube frame, flat bar 12 x 3 mm
- surface: galvanized blue, Cr 3

2-sided	KB2A90051350CS0C801R
3-sided	KB3A90051350CS0C801R
4-sided with single-section door	KB4A90051350CS0C901R
4-sided with two-section door	KB4A90051350CS0C801R



- ideal for Euronorm boxes (also 4-sided)
- low self-weight
- light version
- parcel shipment possible

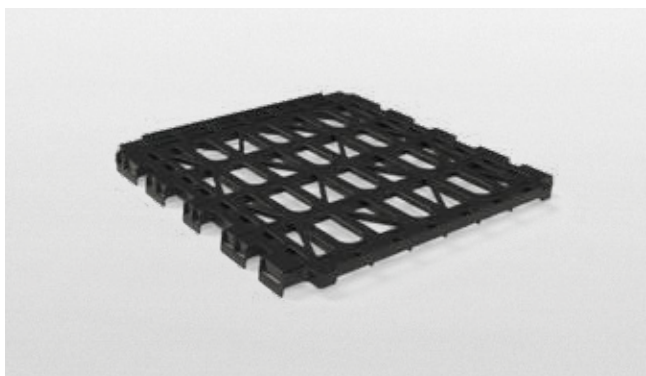

Intermediate shelf

- **2- / 3- / 4-sided** 710 x 778 mm
- made of recycling material
- strengthened with three flat bars
- load capacity: 150 kg

intermediate shelf loose version	E70A23RCF39005
-------------------------------------	----------------

Base BASIC

- **base as transportroller up to 500 kg load capacity:**
724 x 815 x 192 mm
- plastic base made of recycling material
- with two swivel and two fixed castors \varnothing 108 mm, wheel center / tread: polypropylene
- **base with foldable push handle up to 500 kg load capacity:**
724 x 815 x 192 mm / interior: 660 x 815 mm
- plastic base made of recycling material
- with two swivel and two fixed castors \varnothing 108 mm, wheel center / tread: polypropylene

plastic base as transportroller	E10A00RC49005OL-001
plastic base with push handle	KB1A9005815CB00101R



plastic
made of
recycling
material

BASIC
line
just good



rolltainer® ADB BASIC

- **dimensions 3-sided up to 500 kg load capacity:**
724 x 815 x 1.800 mm / interior: 660 x 775 x 1.610 mm
- **dimensions 4-sided up to 500 kg load capacity:**
724 x 815 x 1.800 mm / interior: 660 x 750 x 1.610 mm
- **dimensions 5-sided anti-theft container up to 500 kg load capacity:**
724 x 815 x 1.810 mm / interior: 660 x 750 x 1.585 mm
- large storage space for your products
- flexible arrangement of the intermediate shelves possible every 50 mm
- plastic base made of recycling material
- with two swivel and two fixed castors ø 108 mm, wheel center / tread: polypropylene
- side panel, back wall, door and roof made of ø 22 mm round tube with infill 50 x 50 x 4 mm
- surface: galvanized blue, Cr 3

3-sided	KAD3A90051600COZ101RC
4-sided	KAD4A90051600COZ101RC
5-sided	KAD5A90051600COZ101RC
5-sided with fixed intermediate shelf	KAD5A90051600C1Z101RC



intermediate shelves
variable
insertable

- stable version through \varnothing 22 mm round tube
- lockable – suitable for theft protection
- through the 50 x 50 mm mesh the intermediate shelves are variably insertable

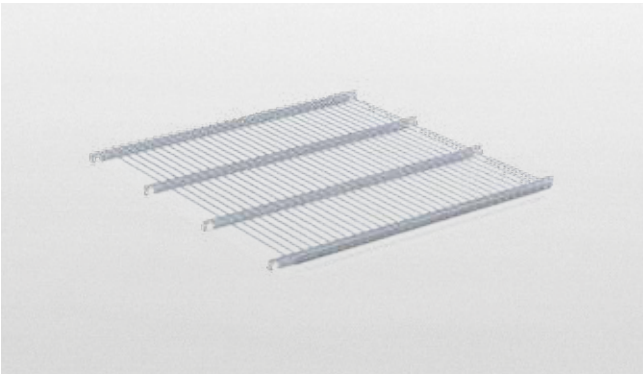

Intermediate shelf

- **2- / 3- / 4-sided** 700 x 705 mm
- wire mesh shelf strengthened with flat bars
- without anti-slip edge
- variable attachable
- surface: galvanized blue, Cr 3
- load capacity: 150 kg

intermediate shelf loose version

ZBD725ADLC000

PARCEL SHIPMENT POSSIBLE

Due to the low self-weight a rolltainer® BASIC can be delivered as a parcel.



Want to see more BASICLine products?
You can find the matching rolldolly® on page 125.

Steel roll containers



Steel roll containers

The steel roll containers are available in different dimensions and designs. In combination with various options there are almost no limits to the applications.

**OUR TOUGH
ONES**
for your
NEEDS



Add further
**INTERMEDIATE
SHELVES**
according to
your wish



numerous
ACCESSORIES
for individual
needs

172



5-SIDED WITH ONE DOOR AND ROOF MADE OF STEEL

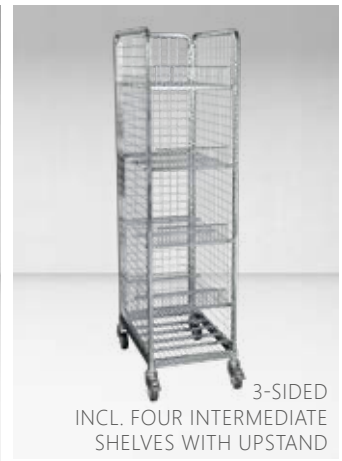

3-SIDED INCL. FOUR INTERMEDIATE SHELVES WITH UPSTAND



4-SIDED INCL. FOUR INTERMEDIATE SHELVES WITHOUT UPSTAND

500 x 680 x 1.860 mm

300 kg

3- / 4- / 5-sided

steel

Steel roll container 1665, 460 x 640 mm

- base made of rectangular tube 40 x 20 mm
- with two swivel and two swivel castors with total brake, ø 100 mm, wheel center / tread: polypropylene / thermoplastic rubber
- side panels, back panel and roof made of square tube 20 mm with mesh 50 x 50 x 4 mm
- intermediate shelves optionally available with or without 100 mm upstand
- surface: galvanized blue, Cr 3

steel roll container 1665, 460 x 640 mm 500 x 680 x 1.855 mm			
	3-sided 415 x 615 x 1.665 mm	4-sided 415 x 615 x 1.665 mm	5-sided 415 x 615 x 1.645 mm
steel roll container without intermediate shelves	S3460640FC057	S4460640FC057	S5460640FC057
steel roll container incl. four intermediate shelves without upstand	S3460640FC4Z057		
steel roll container incl. four intermediate shelves with upstand	S3460640FC4Z057		
intermediate steel shelf, loose version	ZD460ORKFC001		
intermediate steel shelf with upstand, loose version	ZD460MRKFC001		



3-SIDED
INCL. FOUR INTERMEDIATE SHELVES
WITH 100 MM UPSTAND



2-SIDED
INCL. FOUR INTERMEDIATE
SHELVES WITH 20 MM UPSTAND



2-SIDED
INCL. THREE WIRE BASKETS
WITH 100 MM UPSTAND

610 x 610 mm

500 kg

2- / 3-sided

steel

Steel roll container 1490, 600 x 600 mm

- base made of rectangular tube 40 x 20 mm
- 2-sided steel roll container with an additional crossbar made of square tube for stabilization
- with two swivel and two swivel castors with total brake, \varnothing 100 mm, wheel center / tread: polyamide / elastic
- side panels made of square tube 20 mm with mesh 100 x 50 x 4 mm
- intermediate shelves optionally available with 20 mm or 100 mm upstand
- wire basket for 2-sided container available with 100 mm upstand
- surface: galvanized blue, Cr 3

steel roll container 1490, 600 x 600 mm

	steel roll container 1490, 600 x 600 mm	
	2-sided	3-sided
	610 x 610 x 1.675 mm 550 x 600 x 1.490 mm	610 x 610 x 1.655 mm 550 x 580 x 1.490 mm
steel roll container without intermediate shelf	S2600600FC058	S3600600FC058
steel roll container incl. four intermediate shelves with 20 mm upstand	S2600600FC4Z058	S3600600FC4Z058
steel roll container incl. four intermediate shelves with 100 mm upstand	S2600600FC4Z158	S3600600FC4Z158
steel intermediate shelf with 20 mm upstand	ZD600MRKFC001	
steel intermediate shelf with 100 mm upstand	ZD600MRKFC002	
wire basket for 2-sided container with 100 mm upstand	ZD600MRKFC003	-

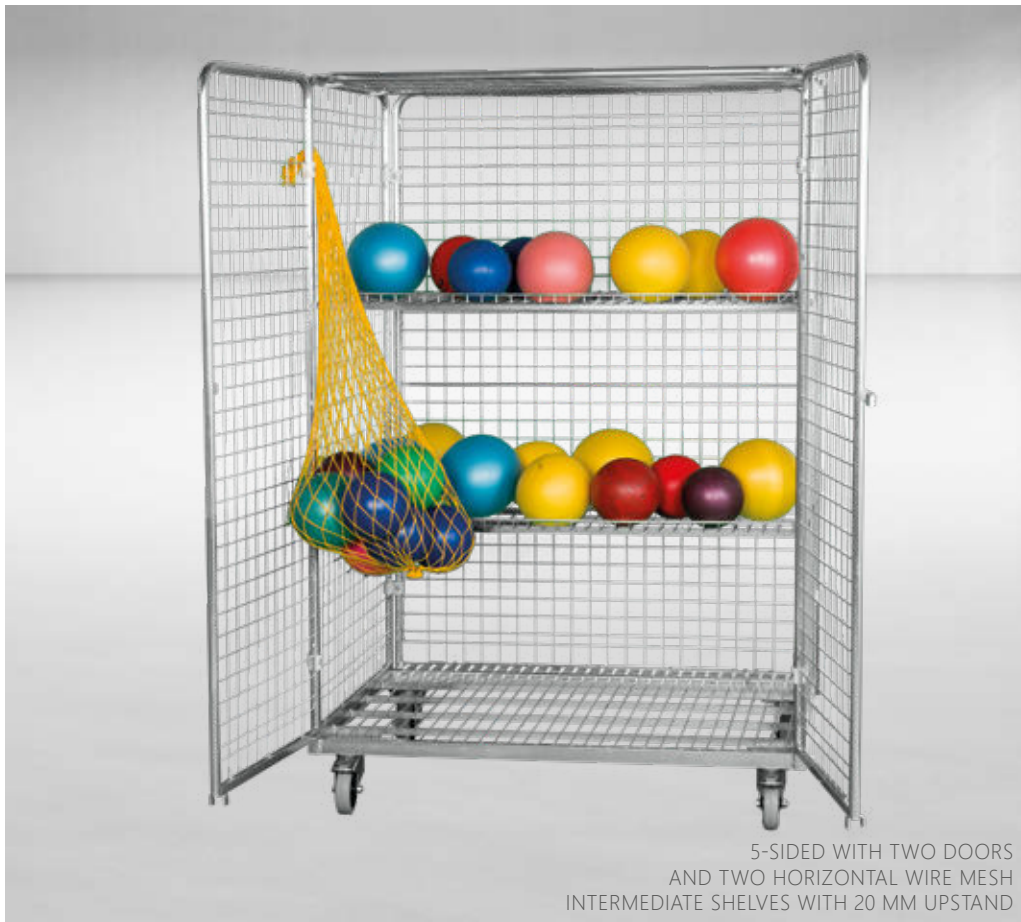

5-SIDED WITH TWO DOORS
AND TWO HORIZONTAL WIRE MESH
INTERMEDIATE SHELVES WITH 20 MM UPSTAND



3-SIDED INCL.
TWO INCLINABLE WIRE MESH
INTERMEDIATE SHELVES



4-SIDED WITH FOLDABLE
AND PIVOTABLE DOOR

 800 x 1.200 mm

 600 kg

 2- / 3- / 4- / 5-sided

 steel

Steel roll container 1600, 800 x 1.200 mm

- base made of rectangular tube 40 x 20 mm
- with two swivel and two swivel castors with total brake, \varnothing 125 mm, wheel center / tread: polyamide / elastic
- all components made of round tube \varnothing 22 mm with mesh 50 x 50 x 4 mm
- optionally available with lockable double wing door or foldable and pivotable door
- surface: galvanized blue, Cr 3

ALL BENEFITS AT A GLANCE



INTERMEDIATE SHELVES WITH
OR WITHOUT UPSTAND

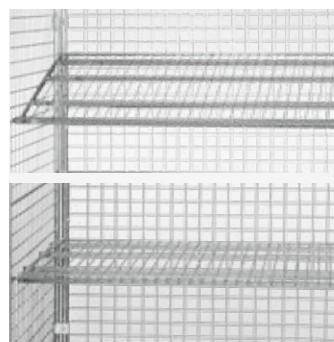

HORIZONTAL OR INCLINABLE
INTERMEDIATE SHELVES



OPTIONALLY AVAILABLE WITH
DOUBLE WING DOOR....



...OR FOLDABLE AND PIVOTABLE
DOOR.

66



4-SIDED INCL. TWO INCLINABLE WIRE MESH INTERMEDIATE SHELVES



3-SIDED



STEEL BASE

800 x 1.200 mm
500 kg
2- / 3- / 4- / 5-sided
steel

	steel roll container 1600, 800 x 1.200 mm		800 x 1.200 x 1.820 mm		
	2-sided 765 x 1.145 x 1.620 mm	3-sided 765 x 1.145 x 1.620 mm	4-sided foldable / pivotable door 740 x 1.145 x 1.620 mm	4-sided double wing door 740 x 1.145 x 1.620 mm	5-sided double wing door 740 x 1.145 x 1.595 mm
steel roll container	S28001200FC053	S38001200FC053	S48001200FC053	S48001200FC153	S58001200FC053
intermediate shelf without upstand	ZD1200ORKFC001				
intermediate shelf 20 mm upstand insertable	ZD1200MRKFC001				
intermediate shelf 20 mm upstand inclinable insertable	ZD1200SRKFC001				
steel base	S08001200FC053				

rolltainer®
nestainer®
Steel roll containers
Laundry containers
rolldolly®
Cargo systems
Special applications
Wheels and castors
Accessories



**IDEAL FOR
EUROPALLETS**



4-SIDED INCL. ONE INTERMEDIATE SHELF



STEEL BASE

5-SIDED WITH FORKLIFT ENTRY LUGS (AVAILABLE AS ACCESSORIES)

950 x 1.350 mm
 800 kg
 3- / 4- / 5-sided
 steel

Steel roll container 1600, 950 x 1.350 mm

- base made of rectangular tube 50 x 20 mm
- with two swivel and two swivel castors with total brake, ø 125 mm, wheel center / tread: aluminium / elastic
- side panels, split back panel, lockable double wing door and roof made of round tube ø 22 mm with mesh 50 x 50 x 4 mm
- optionally available: forklift entry lugs for a secure transport of the container with a forklift (Art.-Nr.: MKUF18090C)
- surface: galvanized blue, Cr 3

steel roll container 1600, 950 x 1.350 mm			
	950 x 1.350 x 1.820 mm	950 x 1.350 x 1.825 mm	
	3-sided 920 x 1.295 x 1.620 mm	4-sided 885 x 1.295 x 1.620 mm	5-sided 885 x 1.295 x 1.595 mm
steel roll container	S39501350FC059	S49501350FC159	S59501350FC059
wire mesh intermediate shelf	ZD1350ORKFC001		
steel base	S09501350FC059		



3-SIDED
INCL. TWO INTERMEDIATE SHELVES



5-SIDED
INCL. ONE INTERMEDIATE SHELF







FORKLIFT ENTRY LUGS
AVAILABLE AS ACCESSORIES

 800 x 1.600 mm
  500 kg
  3- / 4- / 5-sided
  steel

Steel roll container 1600, 800 x 1.600 mm

- base made of rectangular tube 40 x 20 mm
- with two swivel and two swivel castors with total brake, ø 125 mm, wheel center / tread: polyamide / elastic
- side panels, split back panel, lockable double wing door and roof with mesh 50 x 50 x 4 mm
- surface: galvanized blue, Cr 3

	steel roll container 1600, 800 x 1.600 mm  800 x 1.600 x 1.825 mm		
	3-sided  765 x 1.545 x 1.620 mm	4-sided  740 x 1.545 x 1.620 mm	5-sided  740 x 1.545 x 1.600 mm
steel roll container	S38001600FC053	S48001600FC053	S58001600FC053
wire mesh intermediate shelf	ZD1600ORKFC001		
steel base	S08001600FC053		



5-SIDED
INCL. WIRE BASKET TOP FRAME AND THREE INTERMEDIATE
SHELVES (AVAILABLE AS ACCESSORIES)



4-SIDED
INCL. THREE
INTERMEDIATE SHELVES



5-SIDED

620 x 1.500 mm
 500 kg
 3- / 4- / 5-sided
 steel

Steel roll container 620 x 1500 mm

- base made of rectangular tube 40 x 20 mm
- with two swivel and two swivel castors with total brake, ø 125 mm, wheel center / tread: polyamide / elastic
- side panels, split back panel, lockable double wing door and roof made of round tube ø 22 mm with mesh 50 x 50 x 4 mm
- surface: galvanized blue, Cr 3

	steel roll container 620 x 1500 mm		
	3-sided	4-sided	5-sided
	620 x 1.500 x 1.400 mm 585 x 1.445 x 1.200 mm	620 x 1.500 x 1.400 mm 555 x 1.445 x 1.200 mm	620 x 1.500 x 1.400 mm 555 x 1.445 x 1.185 mm
steel roll container 1200 without intermediate shelf	S36201500FC053	S46201500FC053	S56201500FC053
	620 x 1.500 x 1.700 mm 585 x 1.445 x 1.500 mm	620 x 1.500 x 1.700 mm 555 x 1.445 x 1.500 mm	620 x 1.500 x 1.700 mm 555 x 1.445 x 1.485 mm
steel roll container 1500 without intermediate shelf	S36201500FC153	S46201500FC153	S56201500FC153
wire mesh intermediate shelf	ZD6201500MRKFC		
wire basket top frame	BWASF6201500C		
steel base	S06201500FC053		



IDEAL FOR SPORT EQUIPMENT

5-SIDED
INCL. WIRE BASKET TOP FRAME AND FOUR INTERMEDIATE SHELVES WITH 40 MM UPSTAND



3-SIDED
INCL. FOUR INTERMEDIATE SHELVES WITH 40 MM UPSTAND



5-SIDED
INCL. FOUR INTERMEDIATE SHELVES WITH 40 MM UPSTAND

620 x 1.500 mm
 500 kg
 3- / 4- / 5-sided
 steel

Through the following options and features the steel roll containers are especially applicable for the storage of sports equipment:

- variably mountable wire mesh intermediate shelves with 40 mm high upstand in the front
- base also with 40 mm high upstand in the front
- wire basket top frame, 150 mm high, for additional storage space on the steel roll container



WIRE BASKET TOP FRAME

steel roll container ADB 1200, 620 x 1.500 mm 5-sided	620 x 1.500 x 1.400 mm 555 x 1.445 x 1.185 mm
steel roll container incl. three intermediate shelves with 40 mm upstand	S56201500FO3ZC053
steel roll container ADB 1200, 620 x 1.500 mm 5-sided	620 x 1.500 x 1.545 mm 555 x 1.445 x 1.185 mm
steel roll container incl. wire basket top frame and three intermediate shelves with 40 mm upstand	S56201500FA3ZC053
steel roll container ADB 1500, 620 x 1.500 mm 5-sided	620 x 1.500 x 1.700 mm 555 x 1.445 x 1.485 mm
steel roll container incl. four intermediate shelves with 40 mm upstand	S56201500FO4ZC153
steel roll container ADB 1500, 620 x 1.500 mm 5-sided	620 x 1.500 x 1.845 mm 555 x 1.445 x 1.485 mm
steel roll container incl. wire basket top frame and four intermediate shelves with 40 mm upstand	S56201500FA4ZC153



BALL CART WITH BIG SEPARATION GRIDS



BALL CART WITH SMALL SEPARATION GRIDS

BALL CART

610 x 1.040 x 1.000 mm

150 kg

5-sided

steel

Ball cart, 610 x 1040 mm

- foldable ball cart with two tailboards
- with four swivel castors, ø 100 mm, wheel center / tread: polypropylene / thermoplastic rubber
- usable height ca. 870 mm
- mesh 40 x 100 mm
- surface: galvanized blue, Cr 3



ball cart, 600 x 1.040 mm

585 x 950 x 870 mm

ball cart	BW1040C032
separation grid small 610 x 450 mm	BW1040TWKC
separation grid big 840 x 580 mm	BW1040TWGC





STEEL ROLL CONTAINER 1650



CLAMPED BACK PANEL



LOW-NOISE ELASTIC WHEEL

 600 x 800 x 1.795 mm
  400 kg
  3-sided
  steel

Steel roll container 1650, 600 x 800 mm

- frame made of rectangular tube 20 x 20 mm
- with two swivel and two fixed castors, \varnothing 100 mm, wheel center / tread: polyamide / elastic
- two side panels and one back panel made of round tube \varnothing 20 mm with infill made of wire rods \varnothing 6 mm
- quick and easy assembling through clamped back panel
- surface: galvanized blue, Cr 3

steel roll container 1650, 600 x 800 mm

 600 x 800 x 1.795 mm |  545 x 765 x 1.650 mm

steel roll container 3-sided

S3600800CC051



TOTAL THEFT PROTECTION



HANDLE SET

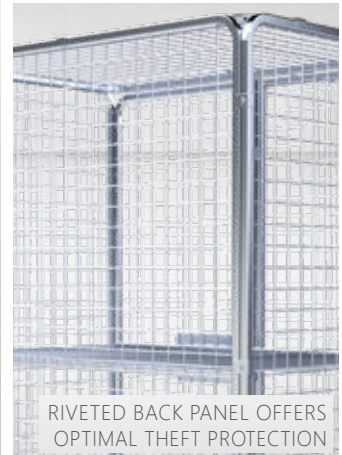

RIVETED BACK PANEL OFFERS OPTIMAL THEFT PROTECTION

5-SIDED INCL. ONE INTERMEDIATE SHELF

800 x 1.200 x 1.820 mm
 500 kg
 5-sided
 steel

Steel roll container ADB 1600, 800 x 1.200 mm

- base made of rectangular tube 30 x 20 mm
- with two swivel and two swivel castors with total brake, ø 125 mm, wheel center / tread: polypropylene
- side panels, back panel, lockable double wing door and roof made of square tube 22 mm with mesh 50 x 50 x 4 mm
- back panel and roof riveted for high theft protection
- vertical locking latch ensures ideal safety
- surface: galvanized blue, Cr 3

	steel roll container ADB 1600, 800 x 1200 mm 800 x 1.200 x 1.820 mm		
	5-sided without intermediate shelf 750 x 1.150 x 1.575 mm	5-sided incl. one intermediate shelf 750 x 1.150 x 1.575 mm	5-sided with visual cover and one intermediate shelf 750 x 1.150 x 1.575 mm
steel roll container	S58001200KCOZ016	S58001200KC1Z016	S58001200KC1Z116
handle set	S5ZUBF002	S5ZUBF002	S5ZUBF002



AVAILABLE WITH
VISUAL COVER



5-SIDED
WITH VISUAL COVER



CHASSIS

5-SIDED
INCL. ONE INTERMEDIATE SHELF
AND VISUAL COVER

 800 x 1.200 x 1.820 mm
  500 kg
  5-sided
  steel

- visual cover made of grey twin-wall sheet optionally available
- perfect privacy protection
- maximum theft protection



MAXIMUM THEFT PROTECTION
THROUGH LOCKABLE DOOR
(PADLOCK NOT INCLUDED IN THE DELIVERY SCOPE)

All benefits at a glance



BACK PANEL AND ROOF RIVETED
FOR HIGH THEFT PROTECTION

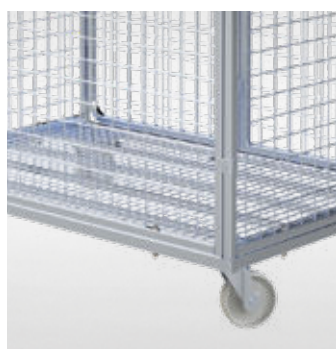

CHASSIS MADE OF
RECTANGULAR TUBE 30 X 20 MM



STURDY, VERTICAL
LOCKING MECHANISM



LOCKING LATCH
WITH HANDLE UNIT

NEW



HANDLE SET



INTERMEDIATE SHELF WITH UPSTAND

2-SIDED INCL. ONE INTERMEDIATE SHELF



800 x 1.200 x 1.800 mm



500 kg



2-sided

steel

Steel roll container 1600, 800 x 1.200 mm

- chassis made of rectangular tube 30 x 20 mm
- side panel and back panel strut made of square tube 22 x 22 mm
- with one swivel castor, one swivel castors with total brake and two fixed castors, ø 125 mm, wheel center / tread: polyamide / polyurethane
- can be loaded from both sides, ideal for order picking
- open back panel, only with a stabilizing strut
- intermediate shelves with and without upstand
- optionally available: handle set (Art.-Nr.: GRKS330C002), retrofittable
- surface: galvanized blue, Cr 3

steel roll container 800 x 1200 mm, 2-sided |  780 x 1.145 x 1.600 mm

steel roll container 800 x 1.200 mm, 2-sided, without intermediate shelf, Cr 3

S38001200KCOZ1E2

wire mesh intermediate shelf for steel roll container, 800 x 1.200 mm, without upstand / insertable, Cr 3

ZD1200DDKC001

wire mesh intermediate shelf for steel roll container, 800 x 1.200 mm, with 20 mm upstand / insertable, Cr 3

ZD1200DDKC002



3-SIDED



2-SIDED WITH HANDLES

415 x 680 x 1.555 mm
500 kg
2-/3-sided
steel

Picking cart S

- chassis made of rectangular tube 30 x 20 mm
- with two swivel and two fixed castors, ø 100 mm, wheel center / tread: polyamide / polyurethane
- two side panels made of square tube 20 x 20 mm with mesh 50 x 50 mm
- load capacity: up to 500 kg / max. 50 kg per level
- only 415 mm wide, perfect for narrow corridors
- surface: galvanized blue, Cr 3

	picking cart  405 x 640 x 1.390 mm
picking cart S, 415 x 680 mm, 2-sided, without intermediate shelf, Cr 3	K2415680KCOZ001E4
picking cart S, 415 x 680 mm, 3-sided, without intermediate shelf, Cr 3	K3415680KCOZ001E4
wire mesh intermediate shelf set for picking cart S, 406 x 640 mm, without upstand / fixed, Cr 3	ZDS680ORKKC001
wire mesh intermediate shelf for picking cart S, 392 x 603 mm, without upstand / insertable, Cr 3	ZD680ORKKC002
wire mesh intermediate shelf for picking cart S, 377 x 603 mm, with 20 mm upstand / insertable, Cr 3	ZD680MRKKC003
wire mesh intermediate shelf for picking cart S, 377 x 603 mm, with 100 mm upstand / insertable, Cr 3	ZD680MRKKC004
separation grid for wire mesh intermediate shelf for picking cart S, 370 mm, insertable, Cr 3	TG680KC004
picking board with clipboard, Cr 3, foldable at an angle	MKTKC02

handle set ME blue, 115 x 400 mm, for picking cart S/M/L GS400K5010002





2-SIDED
INCL. INTERMEDIATE SHELVES



2-SIDED

3-SIDED
WITH FOLDING STEP

510 x 940 x 1.630 mm

300 kg

2-/3-sided

steel

Picking cart M 510

- available in 2 different lengths 940 and 1.340 mm
- 2-sided picking cart with stabilizing strut
- with four bolt hole swivel castors, \varnothing 125 mm, wheel center / tread: polyamide / polyurethane
- two side panels made of square tube 20 x 20 mm with mesh 50 x 50 mm
- load capacity: 300 kg
- surface: galvanized blue, Cr 3

	picking cart 510 x 940 x 1.630 mm	
	2-sided 460 x 850 x 1.425 mm	3-sided 460 x 850 x 1.425 mm
picking cart M, 510 x 940 mm, 2-sided, without intermediate shelf, Cr 3	K2510940KCOZ001J3	K3510940KCOZ001J3
wire mesh intermediate shelf set for picking cart M 940, 460 x 850 mm without upstand / fixed, Cr 3	ZDS940ORKKC001	
wire mesh intermediate shelf for picking cart M 940, 440 x 813 mm, without upstand / insertable, Cr 3	ZD940ORKKC002	
wire mesh intermediate shelf for picking cart M 940, 450 x 810 mm, with 20 mm upstand / insertable	ZD940MRKKC003	
folding step extension kit for picking cart M, Cr 3	KLTS510K7015001	

	picking cart  510 x 1.340 x 1.630 mm	
	2-sided  460 x 1.245 x 1.425 mm	3-sided  460 x 1.245 x 1.425 mm
picking cart M, 510 x 1.340 mm, 2-sided, without intermediate shelf, Cr 3	K25101340KC0Z001J3	K35101340KC0Z001J3
picking cart M, 510 x 1.340 mm, 3-sided, without intermediate shelf, Cr 3		
wire mesh intermediate shelf for picking cart M, 510 x 1.340 mm, without upstand / fixed, Cr 3	ZDS1280ORKK001	
wire mesh intermediate shelf for picking cart M, 510 x 1.340 mm, without upstand / insertable, Cr 3	ZD1280ORKK001	
wire mesh intermediate shelf for picking cart M, 510 x 1.340 mm, with upstand / insertable, Cr 3	ZD1280MRKK001	
folding step extension kit for picking cart M, Cr 3	KLTS510K7015001	

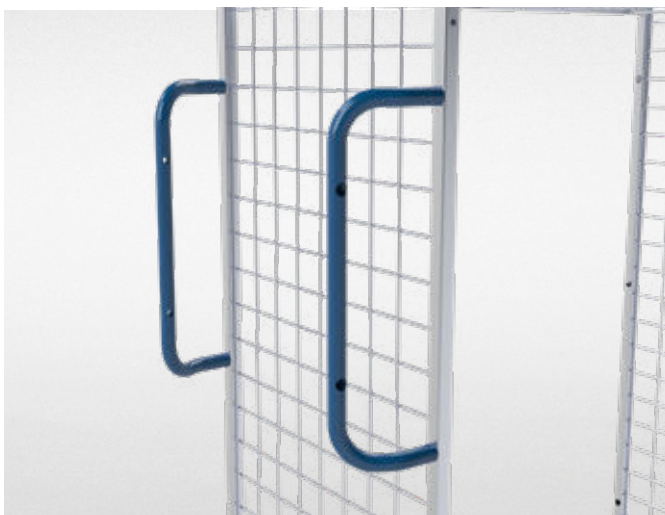
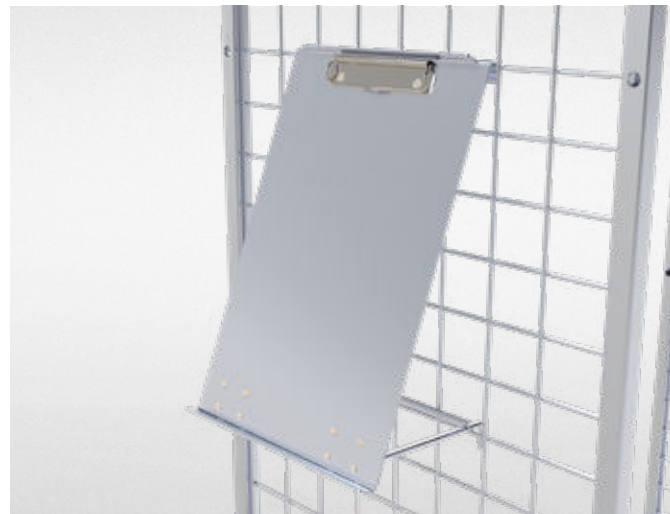

accessories for all picking carts 1425 ME	
5th wheel / guide wheel, ø 125mm	FÜR125KC01V7
picking board with clipboard, inclined mountable, grey	MKTKC02
handle set ME blue, 115 x 400 mm, for picking cart S / M / L	GS400K5010002

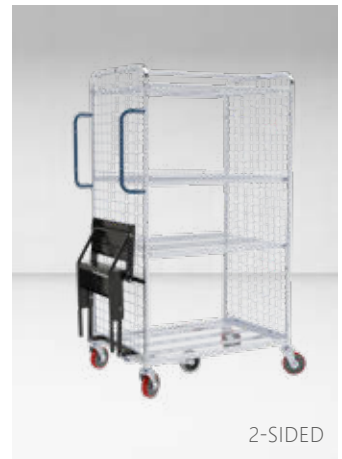

2-SIDED



3-SIDED

3-SIDED
WITH FOLDING STEP AND PICKING BOARD



670 x 940 / 1340 x 1625 mm



300 kg





2-/3- sided



steel

Picking cart L 670

- available in 2 different lengths 940 and 1.340 mm
- 2- and 3-sided version
- 2-sided picking cart with stabilizing strut
- with four bolt hole swivel castors, ø 125 mm, wheel center / tread: polyamide / polyurethan red
- two side panels made of square tube 20 x 20 mm with mesh 50 x 50 mm
- load capacity: 300 kg
- surface: galvanized blue, Cr 3

	picking cart  670 x 940 x 1.625 mm	
	2-sided  620 x 850 x 1.425 mm	3-sided  620 x 850 x 1.425 mm
L, 670 x 940 mm, 2-sided, without intermediate shelf, Cr 3	K2670940KCOZ001J3	K3670940KCOZ001J3
L, 670 x 940 mm, 3-sided, without intermediate shelf, Cr 3		
wire mesh intermediate shelf set for picking cart L 940, 615 x 850 mm, without upstand / fixed, Cr 3		ZDS940ORKKC004
wire mesh intermediate shelf for picking cart L 940, 600 x 810 mm, without upstand / insertable, Cr 3		ZD940ORKKC005
wire mesh intermediate shelf for picking cart L 940, 600 x 810 mm, with 20 mm upstand / insertable, Cr 3		ZD940MRKKC006
folding step extension kit for picking cart L, Cr 3		KLTS620K7015001



	picking cart  670 x 1.340 x 1.625 mm	
	2-sided  620 x 1.250 x 1.425 mm	3-sided  620 x 1.250 x 1.425 mm
picking cart L, 670 x 1.340 mm, 2-sided, without intermediate shelf, Cr 3 picking cart L, 670 x 1.340 mm, 2-sided, without intermediate shelf, Cr 3	K26701340KCOZ001J3	K36701340KCOZ001J3
wire mesh intermediate shelf Set for picking cart L 1340, 615 x 1.250 mm, without upstand / fixed, Cr 3	ZDS1340ORKKC007	
wire mesh intermediate shelf for picking cart L 1340, 600 x 1.200 mm, without upstand / insertable, Cr 3	ZD1340ORKKC008	
wire mesh intermediate shelf for picking cart L 1340, 600 x 1.200 mm, with 20 mm upstand / insertable, Cr 3	ZD1340MRKKC009	
folding step extension kit for picking cart L, Cr 3	KLTS620K7015001	

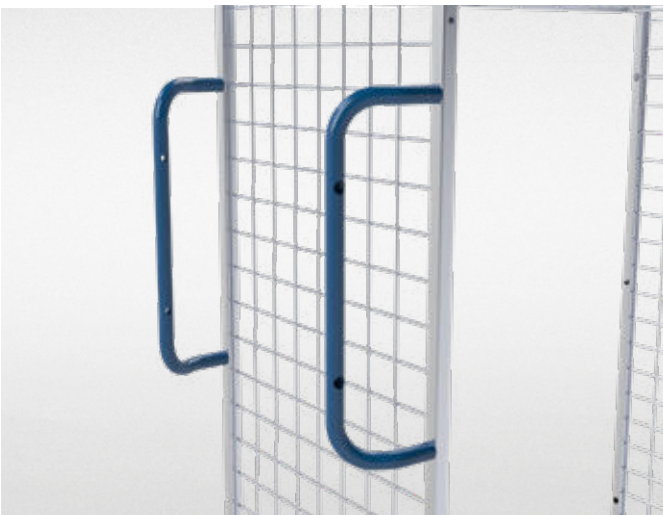
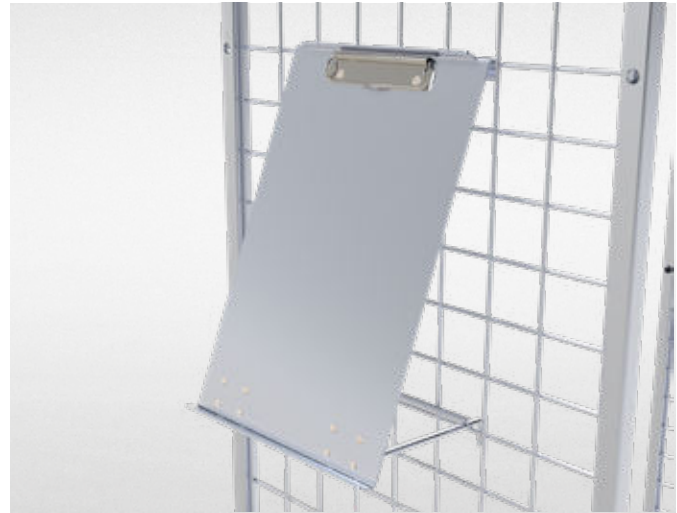

accessories for all picking carts 1425 ME	
5th wheel / guide wheel, ø 125mm	FÜR5125KC01V7
picking board with clipboard, inclined mountable, grey	MKTKC02
handle set ME blue, 115 x 400 mm, for picking cart S / M / L	GS400K5010002

rolltainer®

nestainer®

Steel roll containers

Laundry containers

rolldolly®

Cargo systems

Special applications

Wheels and castors

Accessories



Picking cart XL

- chassis made of rectangular tube 50 x 20 mm
- 2-sided picking cart with stabilizing strut
- with two swivel castors with brake and two fixed castors, ø 160 mm, wheel center / tread: polyamide / polyurethan
- two side panels made of square tube 25 x 25 mm with mesh 70 x 100 mm
- one back panel made of square tube 25 x 25 mm with mesh 50 x 100 mm, insertable
- load capacity: up to 500 kg / base: 200 kg / 150 kg per level
- surface: galvanized blue, Cr 3

	picking cart 800 x 1.247 x 1.400 mm
picking cart XL, 800 x 1.300 mm, 2-sided, without intermediate shelf, Cr 3	K28001300KCOZ001J8
picking cart XL, 800 x 1.300 mm, 3-sided, without intermediate shelf, Cr 3	K38001300KCOZ001J8
separation grid for the base of picking cart XL 800 x 1.300 mm, without upstand / fixed, Cr 3	TGF770200KC001
wire mesh intermediate shelf for picking cart XL 800 x 1.300 mm, without upstand / fixed, Cr 3	ZDS1300ORKK001
separation grid for intermediate shelves of picking cart XL 800 x 1.300 mm, without upstand / fixed, Cr 3	TGZS770200KC001
plywood panel, 750 x 1.245 mm, for base and intermediate shelf of picking cart XL	HPBS75012459SF
upstand for intermediate shelves of picking cart XL 800 x 1.300 mm, fixed, Cr 3	RKZDS123530KC001
grip-set ME blue, 115 x 400 mm, for picking cart XL	GS400K5010001
folding step extension kit for picking cart XL, Cr 3	KLTS800K7015001
forklift entry lugs for steel roll container and picking cart, Cr 3	MKUF18090C
picking board with clipboard, Cr 3, inclined mountable	MKTKC02





FLAP CLOSED



LOADING PLATFORM WITH 30 X 30 MM MESH

FLAP OPENED

800 x 1.200 mm

500 kg

4-sided

steel

Mesh stacking frame VZ on steel base

- chassis made of rectangular tube 30 x 20 mm
loading platform: longitudinal bars made of flat steel with wire frame surface
- with two swivel and two swivel castors with total brake, \varnothing 125 mm, wheel center / tread: polypropylene
- one long side with 1/2 flap, tube frame \varnothing 22 x 1.8 mm,
- surface: galvanized blue, Cr 3

mesh stacking frame galvanized on steel base

800 x 1.200 x 985 mm, usable height 800 mm	S48001200800CS1016
total height 800 x 1.200 x 1.185 mm	S480012001000CS1016
total height 800 x 1.200 x 1.385 mm	S480012001200CS1016

Laundry containers



Laundry containers

Whether in a spa or therm, in hotels, residential and nursing homes or the restaurant business, laundry containers are the perfect solution for in-plant transports of large amounts of laundry. The laundry containers are stable steel containers on castors, which we offer with different bases, side panels and in different sizes. With those large amounts of laundry can be transported, like e.g. towels, working clothes and duvet cover. Through the mounted castors our laundry containers can be moved easily and ensure a good manoeuvrability. Pivotal and foldable doors ensure an easy handling.



rolltainer®

nestainer®

Steel roll containers

Laundry containers

rolldolly®

Cargo systems

Special applications

Wheels and castors

Accessories

NEW

WITH DIRECTIONAL LOCKING SYSTEM

MORE ACCESSORIES AND CASTOR SETS AVAILABLE.

5-SIDED

 875 x 650 x 1750 mm



 400 kg

 5-sided

 Alu

Laundry container 875 x 650 mm

- with four swivel castors (with directional locking system), \varnothing 100 mm, wheel center / tread: polypropylene / thermopl. rubber
- plastic plates and a frame made of aluminium
- incl. 2 foldable intermediate shelves
- surface of the frame: anodized aluminium

laundry container 875 x 650 mm |  875 x 650 x 1.750 mm |  810 x 600 x 1.600 mm

alu

WWK58506301750A2Z000

86



IDEAL FOR
NARROW CORRIDORS



3-SIDED, PLASTIC BOTTOM



4-SIDED, WOODEN BOTTOM

4-SIDED, STEEL BOTTOM

600 x 720 mm
 400 kg
 3- / 4-sided
 plastic / wood / steel

Laundry container 600 x 720 mm

- with two swivel and two fixed castors, \varnothing 100 mm, wheel center / tread: polypropylene / thermopl. rubber
- infill made of round bar \varnothing 6 mm vertical and \varnothing 7.8 mm horizontal
- surface: galvanized blue, Cr 3

	laundry container 600 x 720 x 1.520 mm	
	3-sided 555 x 675 x 1.370 mm	4-sided 555 x 675 x 1.370 mm
steel	WBS36007201520B00000	WBS46007201520B00000
plastic	WBK36007201520B00000	WBK46007201520B00000
wood	WBH36007201520B00000	WBH46007201520B00000

	laundry container 600 x 720 x 1.730 mm	
	3-sided 555 x 675 x 1.580 mm	4-sided 555 x 675 x 1.580 mm
steel	WBS36007201730B00000	WBS46007201730B00000
plastic	WBK36007201730B00000	WBK46007201730B00000
wood	WBH36007201730B00000	WBH46007201730B00000



**WIDE RANGE
FOR EVERY NEED**



3-SIDED, PLASTIC BOTTOM



4-SIDED, WOODEN BOTTOM

3-SIDED, STEEL BOTTOM

600 x 740 mm
 400 kg
 3- / 4-sided
 plastic / wood / steel

Laundry container 600 x 740 mm

- with two swivel and two fixed castors, ø 100 mm, wheel center / tread: polypropylene / thermopl. rubber
- frame made of ø 20 mm round tube, infill made of round bar ø 6 mm vertical and ø 7.8 mm horizontal
- different usable heights available
- surface: galvanized blue, Cr 3

	laundry container 600 x 740 mm	
	3-sided 555 x 695 mm	4-sided 555 x 695 mm
usable height 1.000 mm, steel	WPS36007401150B00000	WPS46007401150B00000
usable height 1.000 mm, plastic	WPK36007401150B00000	WPK46007401150B00000
usable height 1.000 mm, wood	WPH36007401150B00000	WPH46007401150B00000
usable height 1.200 mm, steel	WPS36007401350B00000	WPS46007401350B00000
usable height 1.200 mm, plastic	WPK36007401350B00000	WPK46007401350B00000
usable height 1.200 mm, wood	WPH36007401350B00000	WPH46007401350B00000
usable height 1.370 mm, steel	WPS36007401520B00000	WPS46007401520B00000
usable height 1.370 mm, plastic	WPK36007401520B00000	WPK46007401520B00000
usable height 1.370 mm, wood	WPH36007401520B00000	WPH46007401520B00000





3-SIDED, PLASTIC BOTTOM



4-SIDED, WOODEN BOTTOM

4-SIDED, STEEL BOTTOM

600 x 810 mm
 400 kg
 3- / 4-sided
 plastic / wood / steel

Laundry container 600 x 810 mm

- with two swivel and two fixed castors, \varnothing 100 mm, wheel center / tread: polypropylene / thermopl. rubber
- frame made of \varnothing 20 mm round tube, infill made of round bar \varnothing 6 mm vertical and \varnothing 7.8 mm horizontal

	laundry container 600 x 810 mm	
	3-sided 555 x 765 mm	4-sided 555 x 765 mm
usable height 1.370 mm, steel	WPS36008101520B00000	WPS46008101520B00000
usable height 1.370 mm, plastic	WPK36008101520B00000	WPK46008101520B00000
usable height 1.370 mm, wood	WPH36008101520B00000	WPH46008101520B00000
usable height 1.550 mm, steel	WPS36008101700B00000	WPS46008101700B00000
usable height 1.550 mm, plastic	WPK36008101700B00000	WPK46008101700B00000
usable height 1.550 mm, wood	WPH36008101700B00000	WPH46008101700B00000



AVAILABLE IN
5 USABLE HEIGHTS



3-SIDED, PLASTIC BOTTOM



4-SIDED, WOODEN BOTTOM

4-SIDED, STEEL BOTTOM

 720 x 810 mm
  400 kg
  3- / 4-sided
  plastic / wood / steel

Laundry container 720 x 810 mm

- with two swivel and two fixed castors, \varnothing 100 mm, wheel center / tread: polypropylene / thermopl. rubber
- frame made of \varnothing 20 mm round tube, infill made of round bar \varnothing 6 mm vertical and \varnothing 7.8 mm horizontal
- different usable heights available
- surface: galvanized blue, Cr 3

ALL BENEFITS AT A GLANCE



STEEL BOTTOM



PLASTIC BOTTOM



WOODEN BOTTOM



WITH \varnothing 100 MM TPR CASTORS

90

	laundry container  720 x 810 mm	
	3-sided  675 x 765 mm	4-sided  675 x 765 mm
usable height 1.000 mm, steel	WPS37208101150B00000	WPS47208101150B00000
usable height 1.000 mm, plastic	WPK37208101150B00000	WPK47208101150B00000
usable height 1.000 mm, wood	WPH37208101150B00000	WPH47208101150B00000
usable height 1.200 mm, steel	WPS37208101350B00000	WPS47208101350B00000
usable height 1.200 mm, plastic	WPK37208101350B00000	WPK47208101350B00000
usable height 1.200 mm, wood	WPH37208101350B00000	WPH47208101350B00000
usable height 1.370 mm, steel	WPS37208101520B00000	WPS47208101520B00000
usable height 1.370 mm, plastic	WPK37208101520B00000	WPK47208101520B00000
usable height 1.370 mm, wood	WPH37208101520B00000	WPH47208101520B00000
usable height 1.550 mm, steel	WPS37208101700B00000	WPS47208101700B00000
usable height 1.550 mm, plastic	WPK37208101700B00000	WPK47208101700B00000
usable height 1.550 mm, wood	WPH37208101700B00000	WPH47208101700B00000
usable height 1.650 mm, steel	WPS37208101800B00000	WPS47208101800B00000
usable height 1.650 mm, plastic	WPK37208101800B00000	WPK47208101800B00000
usable height 1.650 mm, wood	WPH37208101800B00000	WPH47208101800B00000



CUSTOM-MADE PRODUCT



Laundry container 1590 / 1600

- with two swivel and two fixed castors, \varnothing 100 mm, wheel center / tread: polypropylene / thermopl. rubber
- two intermediate shelves can be used as front panel
- laundry container 1590 mm with fixed, short front panel and clothes bar
- infill made of round bar \varnothing 6 mm vertical and \varnothing 7.8 mm horizontal
- surface: galvanized blue, Cr 3

	laundry container 1590 940 x 560 x 1.740 mm
	4-sided 400 kg 900 x 520 x 1.590 mm
steel	WS49405601740B2Z000
plastic	WK49405601740B2Z000
wood	WH49405601740B2Z000
	laundry container 1600 850 x 630 x 1.750 mm
	3-sided 500 kg 805 x 590 x 1.600 mm
steel	WWS38506301750B2Z000
plastic	WWK38506301750B2Z000
wood	WWH38506301750B2Z000





STEEL BOTTOM



PLASTIC BOTTOM



WOODEN BOTTOM

 850 x 630 x 1.750 mm

 500 kg

 4-sided

 plastic / wood / steel

Laundry container 1600



- with two swivel and two fixed castors, \varnothing 100 mm, wheel center / tread: polypropylene / thermopl. rubber
- side panels, back panel and foldable front panel
- infill made of round bar \varnothing 6 mm vertical and \varnothing 7.8 mm horizontal
- surface: galvanized blue, Cr 3



DEFLECTION WHEEL



DIRECTIONAL LOCKING SYSTEM

	laundry container 1600 mm  850 x 630 x 1.750 mm
	4-sided  805 x 590 x 1.600 mm
steel	WSS48506301750B00000
plastic	WSK48506301750B00000
wood	WSH48506301750B00000

NEW

MORE ACCESSORIES AND
CASTOR SETS AVAILABLE



METAL BOTTOM



PLASTIC BOTTOM



WOODEN BOTTOM

 825 x 738 x 1.710 mm

 500 kg

 3-sided

 plastic / wood / steel

Laundry container 825 x 738 mm

- with two swivel and two fixed castors, ø 100 mm, wheel center / tread: polypropylene / thermopl. rubber
- incl. two foldable intermediate shelves
- plastic, steel or wooden bottom
- infill made of round bar ø 6 mm vertical and oval bar ø 15 mm horizontal
- surface: galvanized blue, Cr3

laundry container 825 x 738 mm |  825 x 738 x 1.710 mm

3-sided | 500 kg |  755 x 685 x 1.550 mm

steel

WSS38257371710B2Z000

plastic

WSK38257371710B2Z000

wood

WSH38257371710B2Z000

94

NEW



STEEL BOTTOM



PLASTIC BOTTOM



WOODEN BOTTOM

 850 x 630 x 1.750 mm

 500 kg

 4-sided

 plastic / wood / steel

Laundry container 875 x 675 mm

- with two swivel and two fixed castors, \varnothing 100 mm, wheel center / tread: polypropylene / thermopl. rubber
- incl. two foldable intermediate shelves
- plastic, steel or wooden bottom
- infill made of round bar \varnothing 6 mm vertical and oval bar \varnothing 15 mm horizontal
- surface: galvanized blue, Cr3

laundry container 875 x 675 mm |  850 x 630 x 1.750 mm

4-sided |  805 x 590 x 1.600 mm

steel	WSS48506301750B00000
plastic	WSK48506301750B00000
wood	WSH48506301750B00000

NEW

MORE ACCESSORIES AND
CASTOR SETS AVAILABLE



PLASTIC BOTTOM



WOODEN BOTTOM



STEEL BOTTOM



710 x 810 x 1.860 mm



500 kg



5-sided



plastic / wood / steel

Laundry container 710 x 810 mm

- with two swivel and two fixed castors, \varnothing 100 mm, wheel center / tread: polypropylene / thermopl. rubber
- plastic, steel or wooden bottom
- frame made of square tube
- secure storage due to 50 x 50 mm mesh
- infill made of mesh 50 x 50 mm, \varnothing 3.8 mm
- surface: galvanized blue, Cr3

laundry container 710 x 810 mm |  710 x 810 x 1.860 mm

5-sided | 500 kg |  660 x 760 x 1.660 mm

steel

WAS57008001840B00000

plastic

WAK57008001840B00000

wood

WAH57008001840B00000

96

NEW

SMART 2-IN-1 SYSTEM THROUGH
FOLDABLE FRONT PANEL



3-SIDED WITH
THREE INTERMEDIATE SHELVES



3-SIDED WHEN FOLDED



WITH A CLOTHES RAIL



1.185 x 503 x 1.646 mm



400 kg



3-sided



steel

Laundry container 1185 x 503 mm

- with two swivel and two fixed castors, \varnothing 100 mm, wheel center / tread: polypropylene / thermopl. rubber
- incl. three foldable intermediate shelves
- infill made of round bar \varnothing 6 mm vertical and \varnothing 7.8 mm horizontal
- with a clothes rail
- surface: galvanized blue, Cr3

laundry container 1185 x 503 mm |  1.185 x 503 x 1.646 mm

3-/4-sided |  1.140 x 478 x 1.430 mm

steel

RWS311905101600B00000

Accessories for laundry containers



Laundry bag

Laundry bags are suspended on the inside of the laundry container and are used for the collection of dirty laundry. They protect the laundry against further dirt and damages and improve the appearance of the filled container.

fabric:

- 100% polyester
- weight: ca. 220 g/m²
- with thermosetting, durable, easy-care

version:

- toggle closure
- colour: blue / white
- logo printing possible

	laundry container  600 x 720 mm	
	laundry bag white	laundry bag blue
laundry bag 555 x 720 x 1.370 mm for laundry container 600 x 720 x 1.520 mm	WSW6007201520OL	WSB6007201520OL
laundry bag 555 x 720 x 1.580 mm for laundry container 600 x 720 x 1.730 mm	WSW6007201730OL	WSB6007201730OL

	laundry container  600 x 740 mm	
	laundry bag white	laundry bag blue
laundry bag 555 x 735 x 1.000 mm for laundry container 600 x 740 x 1.150 mm	WSW6007401150OL	WSB6007401150OL
laundry bag 555 x 735 x 1.200 mm for laundry container 600 x 740 x 1.350 mm	WSW6007401350OL	WSB6007401350OL
laundry bag 555 x 735 x 1.370 mm for laundry container 600 x 740 x 1.520 mm	WSW6007401520OL	WSB6007401520OL

	laundry container  600 x 810 mm	
	laundry bag white	laundry bag blue
laundry bag 555 x 800 x 1.370 mm for laundry container 600 x 810 x 1.520 mm	WSW6008101520OL	WSB6008101520OL
laundry bag 555 x 800 x 1.550 mm for laundry container 600 x 810 x 1.700 mm	WSW6008101700OL	WSB6008101700OL

	laundry container  720 x 810 mm	
	laundry bag white	laundry bag blue
laundry bag 675 x 800 x 1.000 mm for laundry container 720 x 810 x 1.150 mm	WSW7208101150OL	WSB7208101150OL
laundry bag 675 x 800 x 1.200 mm for laundry container 720 x 810 x 1.350 mm	WSW7208101350OL	WSB7208101350OL
laundry bag 675 x 800 x 1.370 mm for laundry container 720 x 810 x 1.520 mm	WSW7208101520OL	WSB7208101520OL
laundry bag 675 x 800 x 1.550 mm for laundry container 720 x 810 x 1.700 mm	WSW7208101700OL	WSB7208101700OL
laundry bag 675 x 800 x 1.650 mm for laundry container 720 x 810 x 1.800 mm	WSW7208101800OL	WSB7208101800OL

Accessories for laundry containers



Protective cover

Protective covers are used for the transport of clean laundry and are fixed from the outside to the laundry container. Mostly, they are used for the distribution of clean laundry and protect the laundry from dirt and damages.

fabric:

- 100% polyester
- weight: ca. 220 g/m²
- with thermosetting, durable, easy-care

version:

- toggle closure
- colour: blue / white
- logo printing possible

	laundry container 600 x 720 mm	
	protective cover white	protective cover blue
protective cover 600 x 720 x 1.392 mm for laundry container 600 x 720 x 1.520 mm	AHW6007201520OL	AHB6007201520OL
protective cover 600 x 720 x 1.602 mm for laundry container 600 x 720 x 1.730 mm	AHW6007201730OL	AHB6007201730OL

	laundry container 600 x 740 mm	
	protective cover white	protective cover blue
protective cover 600 x 740 x 1.022 mm for laundry container 600 x 740 x 1.150 mm	AHW6007401150OL	AHB6007401150OL
protective cover 600 x 740 x 1.222 mm for laundry container 600 x 740 x 1.350 mm	AHW6007401350OL	AHB6007401350OL
protective cover 600 x 740 x 1.392 mm for laundry container 600 x 740 x 1.520 mm	AHW6007401520OL	AHB6007401520OL

	laundry container 600 x 810 mm	
	protective cover white	protective cover blue
protective cover 600 x 810 x 1.392 mm for laundry container 600 x 810 x 1.520 mm	AHW6008101520OL	AHB6008101520OL
protective cover 600 x 810 x 1.572 mm for laundry container 600 x 810 x 1.700 mm	AHW6008101700OL	AHB6008101700OL

	laundry container 720 x 810 mm	
	protective cover white	protective cover blue
protective cover 720 x 810 x 1.022 mm for laundry container 720 x 810 x 1.150 mm	AHW7208101150OL	AHB7208101150OL
protective cover 720 x 810 x 1.222 mm for laundry container 720 x 810 x 1.350 mm	AHW7208101350OL	AHB7208101350OL
protective cover 720 x 810 x 1.392 mm for laundry container 720 x 810 x 1.520 mm	AHW7208101520OL	AHB7208101520OL
protective cover 720 x 810 x 1.572 mm for laundry container 720 x 810 x 1.700 mm	AHW7208101700OL	AHB7208101700OL
protective cover 720 x 810 x 1.672 mm for laundry container 720 x 810 x 1.800 mm	AHW7208101800OL	AHB7208101800OL

Accessories for laundry containers



intermediate shelf made of steel, insertable

- individually mountable intermediate shelf made of steel
- surface: galvanized blue, Cr 3

for laundry container 600 x 720 mm external dimension (w x d x h): 611 x 660 x 0.5 mm	ZBSL600720B
for laundry container 600 x 740 mm external dimension (w x d x h): 606 x 670 x 0.5 mm	ZBSL600740B
for laundry container 600 x 810 mm external dimension (w x d x h): 606 x 740 x 0.5 mm	ZBSL600810B
for laundry container 720 x 810 mm external dimension (w x d x h): 726 x 740 x 0.5 mm	ZBSL720810B



intermediate shelf made of steel, foldable

- fixed, foldable intermediate shelf made of steel
- surface: galvanized blue, Cr 3

for laundry container 600 x 720 mm external dimension (w x d x h): 615 x 660 x 10 mm	ZBSK600720B
for laundry container 600 x 740 mm external dimension (w x d x h): 610 x 670 x 10 mm	ZBSK600740B
for laundry container 600 x 810 mm external dimension (w x d x h): 610 x 740 x 10 mm	ZBSK600810B
for laundry container 720 x 810 mm external dimension (w x d x h): 730 x 740 x 10 mm	ZBSK720810B



intermediate shelf with textured plastic panel, foldable

- fixed, foldable intermediate shelf with textured plastic panel
- surface: textured plastic panel; mesh: galvanized blue

for laundry container 600 x 720 mm external dimension (w x d x h): 615 x 660 x 10 mm	ZBSKK600720B
for laundry container 600 x 740 mm external dimension (w x d x h): 610 x 670 x 10 mm	ZBSKK600740B
for laundry container 600 x 810 mm external dimension (w x d x h): 610 x 740 x 10 mm	ZBSKK600810B
for laundry container 720 x 810 mm external dimension (w x d x h): 730 x 740 x 10 mm	ZBSKK720810B

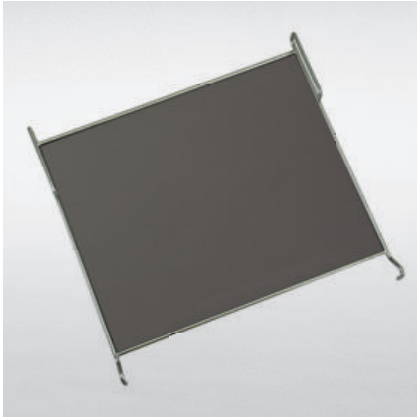

shelf with phenolic resin panel, foldable

- fixed, foldable intermediate shelf with phenolic resin panel
- surface: phenolic resin panel; mesh: galvanized blue, Cr 3

for laundry container 600 x 720 mm external dimension (w x d x h): 615 x 660 x 10 mm	ZBSKH600720B
for laundry container 600 x 740 mm external dimension (w x d x h): 610 x 670 x 10 mm	ZBSKH600740B
for laundry container 600 x 810 mm external dimension (w x d x h): 610 x 740 x 10 mm	ZBSKH600810B
for laundry container 720 x 810 mm external dimension (w x d x h): 730 x 740 x 10 mm	ZBSKH720810B

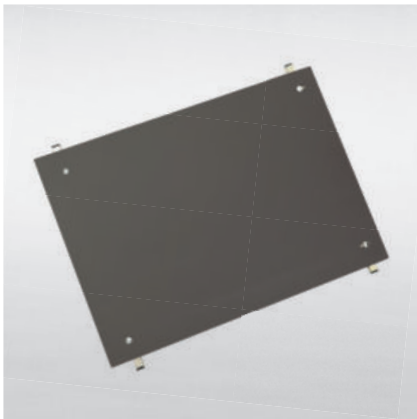

intermediate shelf with phenolic resin panel, insertable

- insertable intermediate shelf with phenolic resin panel
- surface: phenolic resin panel; galvanized blue

for laundry container 600 x 720 mm external dimension (w x d x h): 615 x 660 x 10 mm	ZBSH600720B
for laundry container 600 x 740 mm external dimension (w x d x h): 610 x 670 x 10 mm	ZBSH600740B
for laundry container 600 x 810 mm external dimension (w x d x h): 610 x 740 x 10 mm	ZBSH600810B
for laundry container 720 x 810 mm external dimension (w x d x h): 730 x 740 x 10 mm	ZBSH720810B



gummitex[®], dark grey

- textile strap with elastic
- max. recommended span length 845/900 mm
- colour: dark grey, hook: galvanized blue, Cr 3

textile strap, 1 wire hook / 1 wire loop dimension: 50 x 600 mm	E180001BL
textile strap, 1 wire hook / 1 wire loop dimension: 50 x 640 mm	E180002BL

Accessories for laundry containers

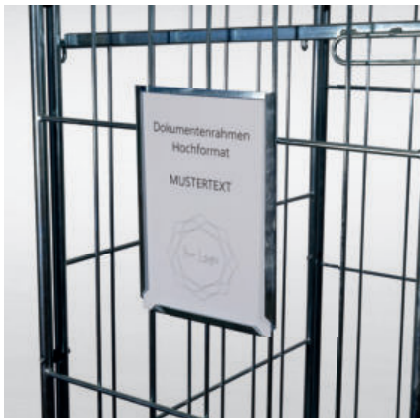

Document frame A4

- optionally available to insert or to rivet / to screw
- surface: galvanized blue, Cr 3

A4 upright format, vertical insertable external dimension (w x d x h): 225 x 305 x 16 mm	DHGA4B
A4 landscape format, vertical insertable external dimension (w x d x h): 305 x 225 x 16 mm	DQGA4B
A4 upright format, to rivet or screw external dimension (w x d x h): 218 x 300 x 16 mm	DHGSA4B
A4 landscape format, to rivet or screw external dimension (w x d x h): 300 x 218 x 16 mm	DQGSA4B



Document frame A5

- optionally available to insert or to rivet / to screw
- surface: galvanized blue, Cr 3

A5 upright format, vertical insertable external dimension (w x d x h): 152 x 212 x 16 mm	DHGA5B
A5 landscape format, vertical insertable external dimension (w x d x h): 212 x 152 x 16 mm	DQGA5B
A5 upright format, to rivet or screw external dimension (w x d x h): 150 x 220 x 16 mm	DHGSA5B
A5 landscape format, to rivet or screw external dimension (w x d x h): 220 x 150 x 16 mm	DQGSA5B



Document frame A6

- optionally available to insert or to rivet / to screw
- surface: galvanized blue, Cr 3

A6 upright format, vertical insertable external dimension (w x d x h): 107 x 152 x 16 mm	DHGA6B
A6 landscape format, vertical insertable external dimension (w x d x h): 152 x 107 x 16 mm	DQGA6B
A6 upright format, to rivet or screw external dimension (w x d x h): 110 x 155 x 16 mm	DHGSA6B
A6 landscape format, to rivet or screw external dimension (w x d x h): 155 x 110 x 16 mm	DQGSA6B

Slip-on chalkboard A5

- vertical slip-on chalkboard
- surface: galvanized blue, Cr 3
- writable surface

A5 upright format, slip-on external dimension (w x d x h): 315 x 150 x 16 mm	AHGSA5B
---	---------



Clothes rail

- vertical insertable
- surface: galvanized blue, Cr 3

for laundry container 600 x 720 mm, 600 x 740 mm and 600 x 810 mm external dimension (w x d x h): 570 x 20 x 20 mm	WKS600B
for laundry container 720 x 810 mm external dimension (w x d x h): 690 x 20 x 20 mm	WKS720B
for laundry container 850 x 630 mm external dimension (w x d x h): 825 x 20 x 20 mm	WKS850B
for laundry container 940 x 560 mm external dimension (w x d x h): 880 x 20 x 20 mm	WKS940B



Deflection wheels

- protect the laundry containers and the surrounding
- wheel center: polypropylene
- wheel tread: thermoplastic rubber
- external dimension: \varnothing 50 mm (external) / \varnothing 22 mm (internal)

for laundry container 3-sided	AWRBP3
for laundry container 4-sided	AWRBP4



Directional locking system

- with only one click / one movement of the foot two swivel castors can be transformed into two fixed castors and back into two swivels.
- for \varnothing 100 mm PP/TPR castors, on request also available for other types of castors
- surface: flame red similar to RAL 3000

for laundry container 600 x 720 mm, 600 x 740 mm and 600 x 810 mm external dimension (w x d x h): 476 x 20 x 20 mm	US450TPE100
for laundry container 720 x 810 mm external dimension (w x d x h): 596 x 20 x 20 mm	US570TPE100
for laundry container 850 x 630 mm external dimension (w x d x h): 506 x 20 x 20 mm	US480TPE100
for laundry container 940 x 560 mm external dimension (w x d x h): 426 x 20 x 20 mm	US400TPE100

rolldolly®



106

rolldolly®

The name is to the point. Rolldolly® stands for quality, durability and need-based configuration. The diversity of variants offers a huge product range. Use the advantages of the particular rolldolly made of plastic, aluminium, steel or stainless steel.

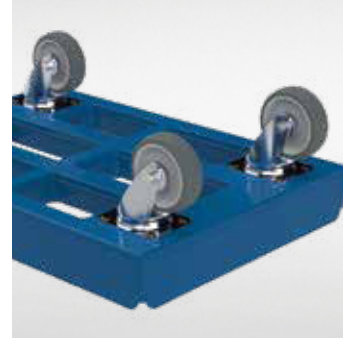

LOGISTIC SOLUTIONS
for special
DEMANDS

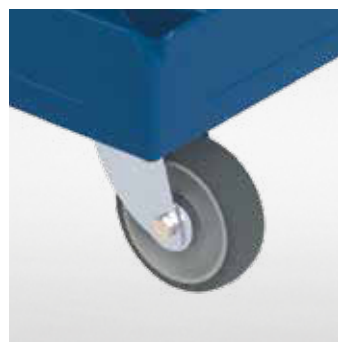

huge
range of
**WHEELS AND
CASTORS**
162

rolltainer®

nestainer®

Steel roll
containers

Laundry
containers

rolldolly®

Cargo systems

Special
applications

Wheels and
castors

Accessories



IDEAL FOR
EURONORM BOX
600 X 400 MM



rollidolly® LIGHT
VERSION CLOSED



rollidolly® LIGHT
VERSION OPEN

rollidolly®

rollidolly® LIGHT VERSION GRID



 415 x 615 x 175 mm

 250 kg

 plastic

rollidolly® LIGHT

- plastic bottom made of high-quality ABS-material
- with four bolt hole swivel castors, ø 100 mm, wheel center / tread: polypropylene / thermopl. rubber
- assembling of the castors with bolt hole: one screw per castor
- other castors possible on request
- standard colours available in traffic red similar to RAL 3020, and traffic blue similar to RAL 5017
- other RAL-colours possible on request

	rollidolly® LIGHT	
	 415 x 615 x 175 mm	 405 x 605 x 20 mm
	traffic red similar to RAL 3020	traffic blue similar to RAL 5017
version open	M410610ABS3020OBLB7	M410610ABS5017OBLB7
version grid	M410610ABS3020RBLB7	M410610ABS5017RBLB7
version closed	M410610ABS3020GBLB7	M410610ABS5017GBLB7



rolldolly® FAVORIT WELDED VERSION



ADAPTER FRAME FOR TRAPEZOID REUSEABLE CONTAINERS

rolldolly® CLASSIC OPEN VERSION

410 x 610 x 190 mm

300 kg

plastic

rolldolly® CLASSIC & FAVORIT

- plastic bottom made of high-quality HDPE-material, version FAVORIT with closed subfloor outline
- ideal securing of the plastic boxes through double safety edge
- easy handling of the empties through build-in stacking holes
- with four swivel castors, ø 100 mm, wheel center / tread: polypropylene / thermopl. rubber
- assembling of the castors with plate: 4 screws per castor
- optionally available for trapezoid reusable containers: adapter frame made of 2 mm thick, galvanized sheet steel
- embossing of the front side and long side possible
- available in colours flame red similar to RAL 3000, gentian blue similar to RAL 5010, light blue similar to RAL 5012, telegrey similar to RAL 7046 and black similar to RAL 9005

rolldolly® CLASSIC/FAVORIT

- 410 x 610 x 190 mm
- 402 x 602 x 15 mm

CLASSIC	F92702PE3000OL029
FAVORIT	F92601PE3000OL029
adapter frame	ARTR400600CM
Handrail bracket for rolldolly® 400 x 600 mm	GSTS800KC001
handle bar	GSTS800KC001



- handle bar made of bent pipe ø 20 mm
- height handle bar ca. 800 mm
- adapter plate for screwing on and inserting the handle bar
- surface: galvanized blue, Cr 3

* The rolldolly® CLASSIC & FAVORIT is apart from the standard colour flame red, similar to RAL 3000, also available in the following colours: gentian blue similar to RAL 5010, light blue similar to RAL 5012, telegrey similar to RAL 7046 and black similar to RAL 9005. To generate the correct colour code, please replace the corresponding digits in the item number. (Ex.: in item number „F92702PE3000OL029“ „3000“ stands for flame red).

rolldolly® XL

CLASSIC & FAVORIT



The rolldolly® XL is designed and optimized for the transport of Euronorm boxes. With up to 500 kg load capacity in an area of 600 x 800 mm it is one of the biggest in the sector. However, its potential is not yet exhausted with these features.



TECHNICAL HIGHLIGHTS

- plastic surface made of high-quality HDPE
- double stacking edge for optimal transport of boxes
- build-in stacking holes for safe and easy handling of empties
- drains ensure quick cleaning
- recessed grips ease the working with the rolldolly®
- The FAVORIT offers with its closed subfloor a HACCP conform logistic
- embossing possible on both front sides

rolldolly® XL CLASSIC & FAVORIT

📏 612 x 814 x 195 mm | 📏 602 x 802 x 15 mm

PP / TPR castors, ø 100 mm, 300 kg load capacity

E50O00PE25010OL025

PA / PU castors, ø 125 mm, 500 kg load capacity

E50O00PE25010OL0G5

Handrail bracket for rolldolly® XL

GSTHS600KC001

handle bar

GSTS800KC001

110



The basic measurement is designed for the ideal utilization of the trucks loading space.

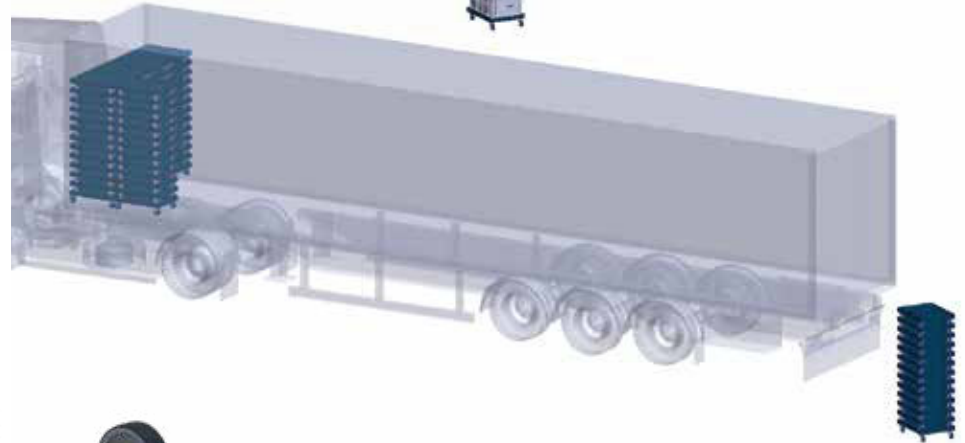



As a result of the excellent stacking, only very few space is needed on the truck for the return of the empty rolldolly XL.



The FAVORIT model has a closed subfloor outline and can be used in areas with high hygienic requirements.

TECHNICAL DATA

-  612 x 814 x 195 mm
-  300 / 500 kg
-  plastic



Optionally, three rows of fixed castors can be fitted to the FAVORIT model. The middle row is positioned lower and serves as pivot point.



300 kg steel / plastic

rollidolly® FLEX

- steel profile frame with four plastic corners, red
- with four bolt hole swivel castors, ø 100 mm, wheel center / tread: polypropylene / thermopl. rubber
- assembling of the castors with bolt hole: one screw per castor
- different special dimensions possible on request

	rollidolly® FLEX
310 x 410 x 170 mm 305 x 405 x 20 mm	M310410S3020BLB7
410 x 610 x 170 mm 405 x 605 x 20 mm	M410610S3020BLB7
610 x 810 x 170 mm 605 x 805 x 20 mm	M610810S3020BLB7
810 x 1.210 x 170 mm 805 x 1.205 x 20 mm	M8101210S3020BLB7



FUNCTIONAL HELPERS IN EVERY AREA



rolltainer®

nestainer®

Steel roll containers

Laundry containers

rolldolly®

Cargo systems

Special applications

Wheels and castors

Accessories



rolldolly[®]

416 X 618 MM
WITH TPR AND PP CASTORS

 418 x 618 x 132 mm

 150 kg

 aluminium

rolldolly[®] ALU

- made of untreated aluminium-angle section
- with four swivel castors, ø 80 mm, wheel center / tread: polypropylene or polypropylene / thermopl. rubber
- assembling of the castors with bolt hole: one screw per castor
- all around safety edge, ideal for the transportation of Euronorm boxes

rolldolly [®] ALU	
 418 x 618 x 132 mm	 409 x 609 x 20 mm
ALU ø 80 polypropylene black	ATR420618031
ALU ø 80 polypropylene / thermopl. rubber grey	ATR420618033

NEW

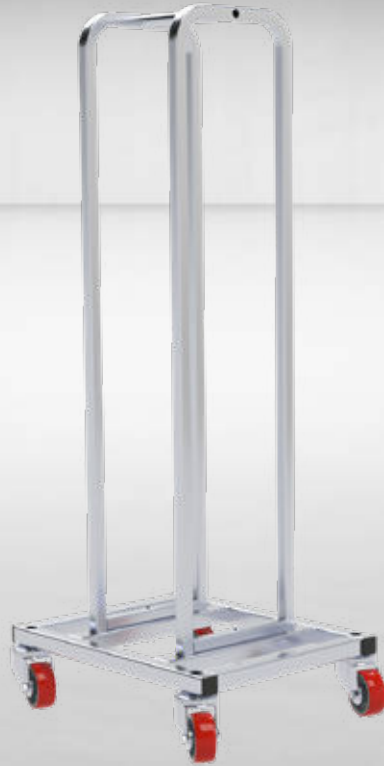

rolldolly®

MODULAR SYSTEM

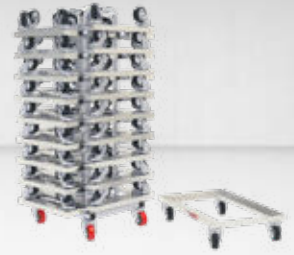

SAFE AND SPACE-SAVING STORAGE



ALSO SUITABLE FOR ROLLDOLLY LIGHT

30 418 x 618 x 132 mm

150 kg

steel

rolldolly® Tower ME 1035

- chassis made of 30 x 30 mm square tube
- with four swivel castors, ø 80 mm, wheel center / tread: polyamide / polyurethane
- tubular frame modular screwable onto the chassis, different usable heights available
- surface: galvanized blue, Cr 3

rolldolly® Tower ME 1035

425 x 500 x 1.170 mm | 385 x 490 x 1.035 mm

rolldolly® Tower ME 1035, 425 x 500 mm, Cr 3

TRT425500KC0184

IDEAL FOR
EURONORM BOX
400 X 600 MM AND
600 X 800 MM

RUST-FREE

400 X 600 MM

600 X 800 MM AND
400 X 600 MM

rolldolly®

300 kg stainless steel

rolldolly® STAINLESS STEEL

- welded stainless steel-frame, front sides made of section tube, long sides made of stainless steel sheet
- three wheels per long side
- six wheels, ø 125 mm, wheel center / tread: polyamide, stainless steel plain bearing, screwed stainless steel axis
- middle wheels are in a lower position, the rolldolly can be rotated on the spot and can easily be slid over an edge

		rolldolly® STAINLESS STEEL
410 x 655 x 170 mm 405 x 603 x 25 mm		ETR4106550H7
615 x 862 x 172 mm 605 x 803 x 30 mm		ETR6158830H7



IDEAL FOR
EUROPALLETS



ROLLDOLLY® STEEL
313 X 413 MM



ROLLDOLLY® STEEL
800 X 1200 MM

 300 / 500 kg
  steel

rolldolly® STEEL

rolldolly® STEEL, 313 x 413 mm

- rolldolly® made of steel, surface powder coated gentian blue similar to RAL 5010
- with three swivel and one swivel castor with total brake, ø 100 mm, wheel center / tread: polyamide / elastic
- assembling of the castors with plate

rolldolly® STEEL, 800 x 1.200 mm

- pallet frame made of steel, surface hot-dipped
- with two swivel and two swivel castors with total brake, ø 125 mm, wheel center / tread: polypropylene
- assembling of the castors with plate

	rolldolly® STEEL
rolldolly® STEEL, 313 x 413 mm, 300 kg  313 x 413 x 168 mm  305 x 405 x 36 mm	STR4133135010012
rolldolly® STEEL, 800 x 1.200 mm, 500 kg  810 x 1.210 x 213 mm  802 x 1.202 x 46 mm	MBR8221220F016



**THE RIGHT SIZE
FOR EVERY DEMAND**



600 X 300 MM
Ø 100 MM POLYPROPYLENE
CASTORS



800 X 600 MM
Ø 125 MM SOLID RUBBER
CASTORS

 200 kg - 1200 kg

 wood with non-slip coating

Furniture dolly

- wooden base made of multiplex plywood with full covering non-slip coating
- with four swivel castors, different diameter and treads possible

	furniture dolly	packing unit
600 x 300 mm, Ø 75 mm thermopl. rubber castors	MR60030075G	2 pieces
600 x 300 mm, Ø 100 mm solid rubber castors	MR600300100G	2 pieces
600 x 300 mm, Ø 100 mm polypropylene castors	MR600300100P	2 pieces
600 x 350 mm, Ø 100 mm solid rubber castors	MR600350100G	2 pieces
600 x 350 mm, Ø 100 mm polypropylene castors	MR600350100P	2 pieces
600 x 400 mm, Ø 125 mm solid rubber castors	MR600400125G	1 piece
600 x 600 mm, Ø 200 mm solid rubber castors	MR600600200G	1 piece
600 x 600 mm, Ø 125 mm polyurethane castors	MR600600125PU	1 piece
800 x 600 mm, Ø 125 mm solid rubber castors	MR800600125G	1 piece
480 x 720 mm, Ø 100 mm solid rubber castors	MR480720100GG	2 piece



Lid KU

600 x 800 mm

- HDPE-plastic in black similar to RAL 9005
- internal dimension: ca. 603 x 803 mm (w x l x h)
- external dimension: ca. 618 x 822 x 93 mm (w x l x h)
- max. stacking load: 2.000 kg

SPECIAL FEATURE

- two lashing straps integrated into the lid (2.000 mm strap length) for hooking onto rolldollys

lid KU black,
600 x 800 mm, 2 lashing straps

LL120035



Lid KU

800 x 1200 mm

- HDPE-plastic in black similar to RAL 9005
- internal dimension: ca. 803 x 1.203 mm (w x l x h)
- external dimension: ca. 810 x 1.210 x 100 mm (w x l x h)
- max. stacking load: 2.000 kg
- geeignet für 4x Euro-Kisten 400 x 600 mm oder 2x 600 x 800 mm, oder 1x 800 x 1.200 mm

SPECIAL FEATURE

- two lashing straps integrated into the lid (2.000 mm strap length) for hooking onto rolldollys

lid KU black,
800 x 1.200 mm, 2 lashing
straps

LL120696



lid for load securing
suitable for rolldolly® INDUSTRY
and adapter pallet INDUSTRY

NEW

OPTIONALLY AVAILABLE
WITH CATCH CORNER

STACKABLE

OPTIONALLY
AVAILABLE

CATCH CORNER
FOR
MOBILE FRAME
400 X 600 MM



IDEAL FOR EURONORM BOXES

rollidolly® INDUSTRY
MOBILE FRAME 400 X 600 MM

rollidolly® INDUSTRY chassis 400 x 600 mm

- chassis made of rectangular tube: 15 x 30 mm
- wheelbase: 317 x 400 mm (centre - centre wheel)
- loading surface and storage height: 142 mm
- with four bolt hole swivel castors, ø 100 mm, wheel center / tread: polypropylene
optionally: four bolt hole swivel castors, ø 100 mm, wheel center / tread: polyamide, electric conductive: max. 105 Ohm leakage resistance
- external dimensions: 400 x 600 x 157 mm (l x w x h)
- internal dimensions: 370 x 570 mm
- max. load capacity: 250 kg
- surface: steel parts galvanized blue, Cr 3

Catch corner for chassis 400 x 600 mm

- catch corner made of laser-cut sheet steel t = 2 mm, conically edged
- four holes ø 5.5 mm, including four blind rivets 5 x 12 mm
- surface: galvanized blue, Cr 3

	4 swivel castors ø 100 mm, PP white	4 swivel castors ø 100 mm, PA black, max. leakage resistance 105 Ohm
rollidolly® INDUSTRY	FR400600C0R7	FR400600C0R8
Catch Corner		FEK157402C

120

NEW

STABLE STORAGE- AND
TRANSPORT SYSTEM

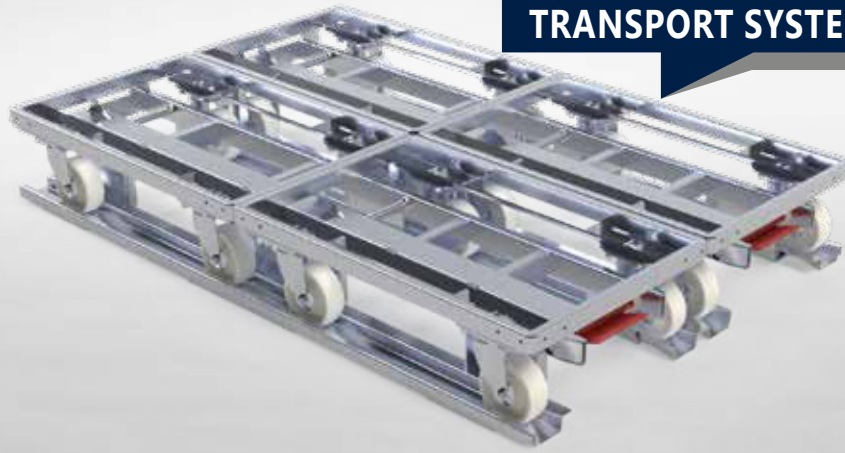

ADAPTER PALLET WITH
4 X rolldolly® INDUSTRY, 400 X 600 MM



ADAPTER PALLET
INDUSTRY 1200 X 800 MM

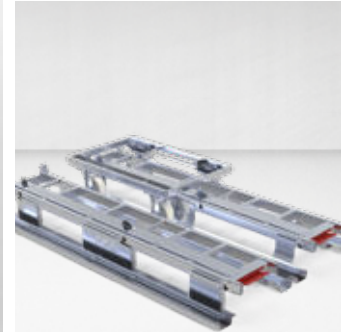

ADAPTER PALLET WITH
rolldolly® INDUSTRY

Adapter pallet INDUSTRY 1200 x 800 mm

- extreme stable storage and transport system for rolldolly® INDUSTRY, 400 x 600 mm, 600 x 800 mm, 800 x 1.200 mm
- intuitive locking system of the rolldolly® via one-foot operation
- the „space saver“ for storage and transport space
- europallet dimensions 1.200 x 800 mm
- stackable (15-times)
- optimal material flow management in combination of roller unit and forklift capability
- forklift pickup on short and long side
- electric conductive (ESD)

TECNICAL DATA:

- external dimensions: 800 x 1.210 x 125 mm
- loading capacity:
 - > 4x rolldolly® INDUSTRY, 400 x 600 mm
 - > 2x rolldolly® INDUSTRY, 400 x 600 mm + 1x rolldolly® INDUSTRY, 600 x 800 mm
 - > 2x rolldolly® INDUSTRY, 600 x 800 mm
 - > 1x rolldolly® INDUSTRY, 800 x 1.200 mm
- self-weight: 32 kg
- load capacity: 1.000 kg
- surface: galvanized blue,Cr 3

adapter pallet INDUSTRY

APA8001200C001

NEW

IDEAL FOR
**EUROPALLETS AND
EUROPALLET CAGES**



CARRIER



CARRIER WITH
STACKING FRAME



CARRIER WITH
STACKING FRAME

Pallet carrier and stacking frame

- chassis made of sturdy welded angle steel construction 50 x 50 x 5 mm
- castors optionally with a tread made of TPR, polyamide, heavy-duty elastic or PULastic
- catching plates welded to all four corners for safe loading of the pallet carrier
- all chassis can be retrofitted with a stacking frame as well as a drawbar and coupling
- surface: hot-dipped

pallet carrier, 1.210 x 810 mm, hot-dipped |  1.260 x 860 x 350 mm

750 kg, TPR castors

FR8101210HD0P2

1.200 kg, polyamide castors

FR8101210HD0P4

1.200 kg, heavy duty elastic castors

FR8101210HD0I9

2.000 kg, polyurethane-elastic castors (PULastic)

FR8101210HD0O6

stacking frame, 1.200 x 800 mm, hot-dipped |  1.260 x 860 x 200 mm

stacking frame, H=160 mm

AR8101210160HD

stacking frame, H=260 mm

AR8101210260HD

stacking frame, H=360 mm

AR8101210360HD

122

NEW

PALLET CARRIER CAN BE MOVED
IN A COMPOUND FOR A
**LIFTING AND FORKLIFT-FREE
PRODUCTION**



CARRIER IN A COMPOUND
TUGGER TRAIN



CARRIER WITH
PUSH HANDLE



CARRIER WITH DRAWBAR
AND COUPLING SYSTEM

Drawbar and coupling set and push handle for carriers

- spring-supported drawbar, length: 500 mm, eye \varnothing 30 mm
- coupling mandrel made of shaft \varnothing 25 mm with drill hole for safety pin (not included)
- comes standard with the drawbar mounted on the side of the swivel castors
- surface: hot-dipped

push handle for pallet carrier,
 \varnothing 27 mm, screwable, hot-dipped

GSTK600805HD

drawbar and coupling set,
Cr 3, for steell roll containers
800 x 1.200 mm and 950 x 1.350 mm

FDSPFC

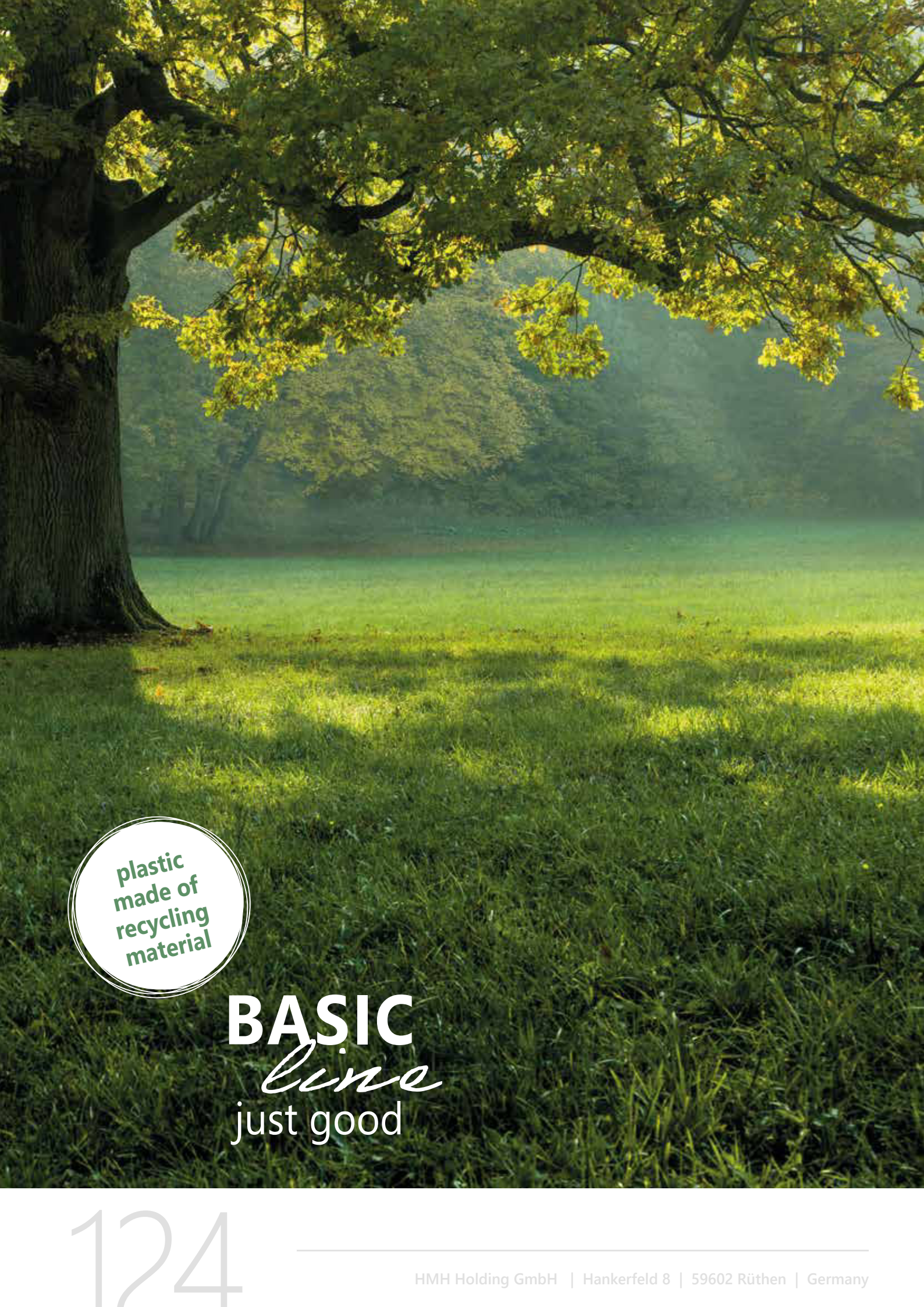

plastic
made of
recycling
material

BASIC
line
just good

124

rolldolly®



rolldolly® BASIC

rolldolly® BASIC

- up to 300 kg load capacity
- external dimension: 610 x 410 x 190 mm
- internal dimension: 602 x 402 mm
- transportroller for Euronorm boxes 600 x 400 mm
- plastic base made of recycling material
- with four swivel castors, ø 100 mm, wheel center / tread: polypropylene / thermoplastic rubber
- ideal securing of the plastic boxes through double safety edge

rolldolly® XL BASIC

- up to 300 kg load capacity
- external dimension: 612 x 814 x 195 mm / interior: 602 x 804 mm
- plastic base made of recycling material
- with two swivel and two fixed castors ø 100 mm wheel center: polypropylene tread: thermoplastic rubber
- ideal securing of the plastic boxes through double safety edge

rolldolly® BASIC	F92702RC9005OL029
rolldolly® XL BASIC	E50000RC29005OL025

Want to see more BASICLine products?
 You can find the right rolltainer® and ADB on page 44-46.

Cargo systems



Cargo systems

The europallet is the carrier par excellence. However, the full potential often can only be tapped with the right top parts. In the following chapter you can find the right stacking frames for your business. Choose between different usable heights and powder coated or galvanized surfaces. Certainly you will find further interesting accessories for optimizing your logistics.



Very good and functional
LOGISTIC SOLUTIONS



All models are
EASY TO ASSEMBLE
and provide a
FIRM SUPPORT



rolltainer®

nestainer®

Steel roll containers

Laundry containers

rolldolly®

Cargo systems

Special applications

Wheels and castors

Accessories

EASY CARRYING – ECONOMIZES
FORKLIFT AND LIFTING CAR



EUROPALLET



EUROPALLET ROLLER SET

 800 x 1.200 x 144 mm

 1.000 kg

Europallet and europallet roller

europallet

- produced according to UIC-Norm 435-2
- SGS certified
- EPAL control clamp
- chamber-dried
- with IPPC-treatment
- logs made of solid wood

europallet roller

- set made of 2 europallet rollers
- each with two swivel castors, \varnothing 100 mm , wheel center / tread: aluminium / polyurethane
- incl. slot for easy handling

	europallets
europallet new	EUPA8001200
europallet used	EUR8001200G
europallet roller set, \varnothing 100 aluminium / polyurethane	EUPAROC-0C9



800 x 1.200 mm
 800 kg
 4-sided
 steel

Mesh stacking frame PB

- suitable for europallet 800 x 1200 mm
- tube frame made of \varnothing 22 mm round tube
- one long side with 1/2 flap
- four catching plates for optimal stacking
- net load: 800 kg
- extra load: 1.600 kg
- surface: powder coated, may green similar to RAL 6017



	mesh stacking frame powder coated
800 x 1.200 x 400 mm, 100 x 100 mesh	AR80012004006017S1
800 x 1.200 x 800 mm, 100 x 100 mesh	AR80012008006017S1
800 x 1.200 x 1.000 mm, 100 x 100 mesh	AR800120010006017S1
800 x 1.200 x 1.200 mm, 100 x 100 mesh	AR800120012006017S1
800 x 1.200 x 1.600 mm, 100 x 100 mesh	AR800120016006017S1
800 x 1200 x 800 mm, 50 x 50 mesh	AR80012008006017S3
800 x 1.200 x 1.000 mm, 50 x 50 mesh	AR800120010006017S3



800 x 1.200 x 1.000 MM
100 x 100 MESH
FLAP OPEN



800 x 1.200 x 1.000 MM
100 x 100 MESH
FLAP CLOSED



THREE TIMES STACKABLE

800 x 1.200 mm
 800 kg
 4-sided
 steel

Mesh stacking frame VZ

- suitable for europallet 800 x 1200 mm
- tube frame made of \varnothing 22 mm round tube
- one long side with 1/2 flap
- mesh: 100 x 100 x 3.8 mm
- four catching plates for optimal stacking
- net load: 800 kg
- extra load: 1.600 kg
- available in three different usable heights
- surface: galvanized blue, Cr 3

Special solutions possible!
Please contact us!



	mesh stacking frame galvanized
800 x 1.200 x 800 mm, 100 x 100 mesh	AR8001200800CS1
800 x 1.200 x 1.000 mm, 100 x 100 mesh	AR80012001000CS1
800 x 1.200 x 1.200 mm, 100 x 100 mesh	AR80012001200CS1

NEW

**LONG SIDE WITH
1/2 FLAP**



4-SIDED, FOLDABLE



FOLDED AND STACKED



STACKABLE

 500 kg









 4-sided

 steel

Wire mesh container ME

- foldable wire mesh container made of wire mesh \varnothing 5 und 10 mm
- one long side with 1/2 flap
- side panel, back panel and front panel foldable when empty
- 15-times stackable when empty
- 3-times stackable when loaded
- mesh: 50 x 100 mm
- net load: 500 kg
- extra load: 1.500 kg
- all versions come with wheel plates, optionally available with castors
- surface: galvanized blue, Cr 3

**Optionally
available
with castors**

	wire mesh container ME
wire mesh container ME, 600 x 800 mm, 4-sided  610 x 800 x 620 mm  550 x 700 x 466 mm	S4600800600CC1100
wire mesh container ME, 800 x 1.000 mm, 4-sided  810 x 1.000 x 870 mm  750 x 900 x 716 mm	S48001000850CC1100
wire mesh container ME, 800 x 1.200 mm, 4-sided  810 x 1.200 x 920 mm  750 x 1.100 x 766 mm	S48001200900CC1100
wire mesh container ME, 1.000 x 1.200, 4-sided  1.010 x 1.200 x 920 mm  950 x 1.100 x 766 mm	S410001200900CC1100



DISPOSAL CONTAINER
ON PLASTIC PALLET



DISPOSAL CONTAINER
ON PLASTIC PALLET



DISPOSAL CONTAINER
ON WOODEN PALLET



800 x 1.200 x 1.780 mm



500 kg





3- / 4-sided



steel / plastic / wood

Disposal container on wooden or plastic pallet

- 3- / 4-sided container, permanently mounted on a plastic pallet 800 x 1200 mm, made of HDPE-recycling material
- alternatively mounted on a europallet with a galvanized mounting frame
- side panels, back panel and foldable front panel made of round tube \varnothing 22 mm, mesh 50 x 50 x 4 mm
- surface: galvanized blue, Cr 3

	disposal container	
	3-sided  770 x 1.150 x 1.600 mm	4-sided  750 x 1.150 x 1.600 mm
disposal container plastic	S38001200FC0KU	S48001200FC0KU
disposal container wood	S38001200FC0HO	S48001200FC0HO

Haven't found the right product yet?

Special applications are one of our specialities: We would be happy to develop a cargo system with you, which is precisely tailored to your needs. Feel free to contact us!



**FEEL FREE
TO CONTACT
US!**
+49 2952 - 970958-80



FOLDABLE TO
SAVE SPACE



WOODEN STACKING FRAME WITH DIVIDER



STACKING CORNERS AVAILABLE AS ACCESSORIES

WOODEN STACKING FRAME

 800 x 1.200 x 195 mm
  4-sided
  wood

Wooden stacking frame

- 1 plank version, 20 mm
- four hinges
- planed material
- chamber-dried
- with IPPC-treatment
- longitudinal and cross divider available each with three slots
- stacking corners made of plastic for more stability (available as accessories)

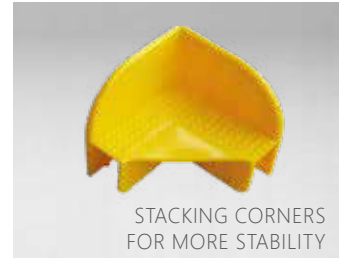
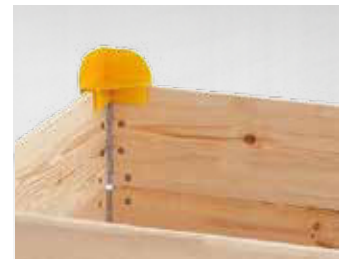

STACKING CORNERS FOR MORE STABILITY

	wooden stacking frame
wooden stacking frame height 195 mm	HOAR8001200
longitudinal divider with three slots	TWH11601933
cross divider with three slots	TWH7601933
stacking corner KU for wooden stacking frame	HOARSTE1021

PalletEdge

Pallet spacer for pallets with stacking frame

- consisting of 4 stacking posts
- height: 250 mm
- static load capacity: up to 1.000 kg
- material: steel, galvanized blue, Cr 3
- attachable and lockable
- corner assembly for stacking loaded pallets



PalletEdge in height 250 mm	WKE-1-250-00
PalletEdge in height 350 mm	WKE-1-350-00
PalletEdge in height 500 mm	WKE-1-500-00

PalletStack Pro

Rigid and telescopic pallet stacking system for europallet dimensions

- dimensions (l x w x h): 1.220 x 820 x 330-490 mm
- load capacity: 200 kg
- telescopic corner bracket, galvanized blue, Cr 3
- side parts made of aluminium
- perfect load securing on the pallet
- unit loads can be accessed from all 4 sides

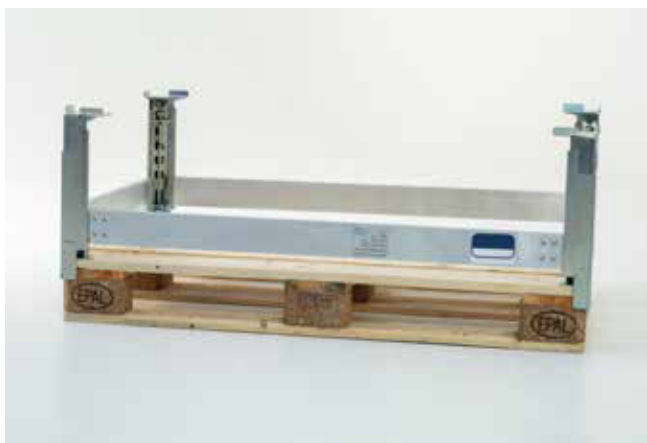

PalletStack Pro – foldable, telescopic corner brackets	WKP1001-00
PalletStack Pro – rigid, telescopic corner brackets	WKP1001-S-00
PalletStack Classic - foldable, rigid corner brackets	WKP1001-01
PalletStack Classic - rigid, rigid corner brackets	WKP1001-S-01

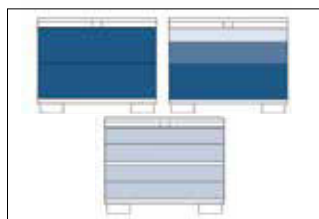

SteelBox Basic

Drawer box made of sturdy sheet steel construction

- external dimensions: 1.250 x 860 x 940 / 1.020 mm
- number of drawers: 2, fully extendable
- 2 x size L (1.050 x 750 x 331 mm)
- colour of the drawers: Dust gray (RAL 7037)
- colour of the body: Papyrus white (RAL 9018)
- drawers with heavy-duty telescopic bottom runner
- lockable with pull-out stop, stackable
- stacking pockets with integrated lashing and lifting eyes
- work surface made of weather-resistant screen printing plate
- illustration similar, without accessories
- load capacity: 75 - 120 kg

SteelBox Basic

WKGIS-02-01-0



SteelBox Pro

Drawer box made of sturdy sheet steel construction

- external dimensions: 1.250 x 860 x 940 / 1.020 mm
- number of drawers: 2, fully extendable
- sizes:
 - XS 1/6 drawers: 1.050 x 750 x 106 mm
 - M 1/3 drawers: 1.050 x 750 x 218.5 mm
 - L 1/2 drawers: 1.050 x 750 x 331 mm
- colour of the drawers: Signal blue (similar to RAL 5005)
- colour of the body: Stone grey (similar to RAL 7030)
- drawers with heavy-duty telescopic bottom runner
- safety closing and locking system
- stacking pockets with integrated lashing and lifting eyes
- work surface made of weather-resistant screen printing plate
- illustration similar, without accessories
- load capacity: 75 - 120 kg

A wide range of accessories is optionally available.

SteelBox Pro

WKGIS-03-01-0



ANGLE FRAME 3-SIDED WITH PUSH HANDLE

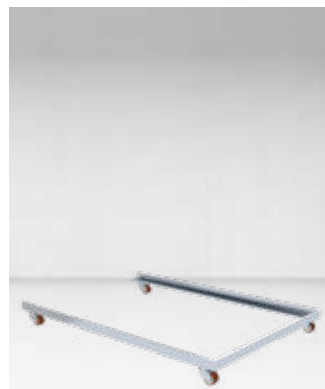

ANGLE FRAME 3-SIDED



ANGLE FRAME FOR PALLET CAGE

500 kg

steel

Angle frame for pallets and pallet cages

- open angle frame optionally available with push handle
- pallets and pallet cages can easily be placed per lifting car
- load capacity: 500 kg
- angle frame made of 60 x 40 x 6 mm angles
- push handle made of \varnothing 27 mm round tube; surface: galvanized blue; Cr 3
- dimensions of push handle: 600 x 175 x 805 mm
- with four bolt hole swivel castors, \varnothing 50 mm, wheel center / tread: steel / polyurethane
- surface: galvanized blue, Cr 3

	angle frame
angle frame ME, 600 x 800, 3-sided, with push handle 605 x 960 x 110 mm 600 x 820 x 34 mm	WRK606833GSTC0F9
angle frame ME, 600 x 800, 3-sided 605 x 835 x 110 mm 600 x 820 x 34 mm	WRK606833C0F9
angle frame ME, 800 x 1200, 3-sided, with push handle 835 x 1.330 x 110 mm 820 x 1.200 x 34 mm	WRK1206833GSTC0F9
angle frame ME, 800 x 1200, 3-sided 835 x 1.330 x 110 mm 820 x 1.200 x 34 mm	WRK1206833C0F9
push handle for angle frame ME 600 x 800 / 800 x 1.200 mm 600 x 805 x 175 mm	GSTK600805C

Insulated container

FACH-PAK containers consist of a double-walled PE base body, which is filled with either PU or PE foam. This double-walled structure gives the container its insulating properties, which is where it gets its name. Thanks to certified materials, the containers are suitable for contact with food and are therefore particularly well suited for use in the fish, meat, and food industries.

This basic structure, which is manufactured monolithically - from a single piece - ensures that the containers are more stable and impact-resistant. This also enables cross-industry use, for example in manufacturing. The smooth walls allow for easy hygienic cleaning and resistance to a variety of oils, acids, and alkalis.

Right from the beginning, **FACH-PAK** has placed great importance on compatibility, ensuring that many of our products are stackable with our competitors' standard products. This allows for flexibility without having to replace the existing product portfolio.

Your containers can be customized with your logo or graphics. We use techniques such as screen printing, engraving, or in-mold marking for this purpose.

Our products available from stock are highlighted in bold in the tables. The standard colour is blue. Other colours can be found in the colour coding and are available from one piece.

For further information, we recommend our main catalog for insulated containers, or we are of course also happy to assist you.

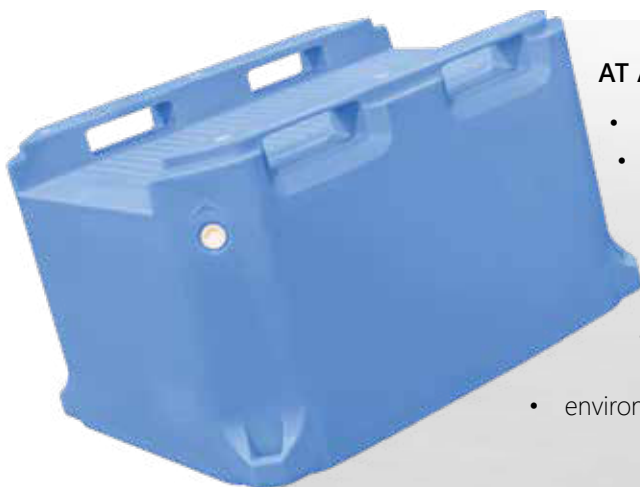

AT A GLANCE:

- standard colour: blue, costum colours and individual printing available
- double-walled insulated containers made of new PE material either with foamed insulation made of PE or PUR (on request)
- resistant to a variety of oils, acids, and alkalis, therefore also perfectly suitable for workshops and production facilities
- easy to clean thanks to the completely closed and smooth surface
- extremely stable and durable, can be reused as often as desired, easy to repair in case of minor damage
- environmentally friendly and sustainable - 100% recyclable

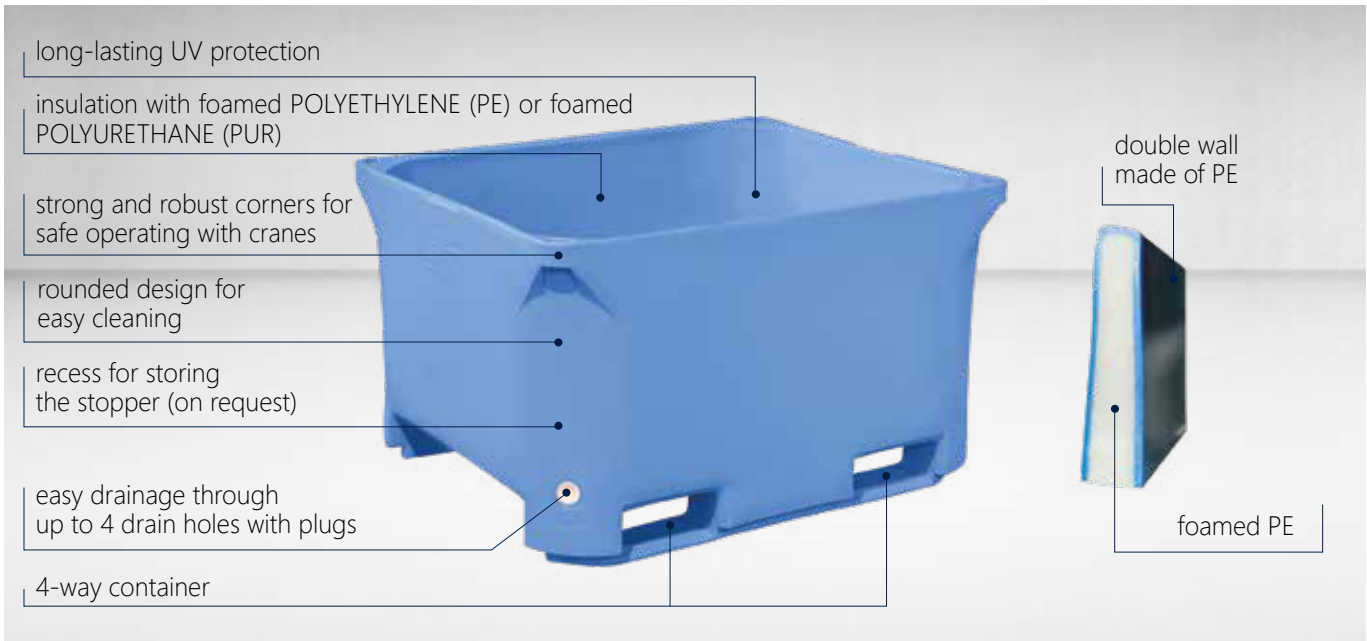

Typ 460 PE

Insulated container

- it is suitable, for example, for transporting fresh fish and seafood
- for storing fresh raw materials
- very durable and resistant
- external dimension: 1.230 x 1.030 x 580 mm
- capacity: 445 l
- material: PE-1A
- insulation: polyethylene foam (PE)
- 4 drain holes with plugs

Insulated Container | Typ 460 ICF460APEOL5010



Typ 605 PE

Insulated container

- especially suitable for meat and poultry processing industry
- external dimension: 1.200 x 1.000 x 760 mm
- capacity: 605 l
- material: PE-1A
- insulation: polyethylene foam (PE)
- 2 drain holes with plugs
- 4 non-slip stacking corners

Insulated Container | Typ 605 ICF605APEOL5010



Typ 630 PE

Insulated container

- multifunctional container, especially recommended for fish and meat processing industry, aquaculture, transport and other sectors
- with high thermic insulation characteristics
- external dimension: 1.200 x 1.000 x 785 mm
- capacity: 630 l
- material: PE-1A
- insulation: polyethylene foam (PE)
- 2 drain holes with plugs

Insulated Container | Typ 630

ICF630APEOL5010



Typ 660 PE

Insulated container

- especially recommended for fish and meat processing industry, aquaculture, transport and other sectors
- external dimension: 1.230 x 1.030 x 750 mm
- capacity: 630 l
- material: PE-1A
- insulation: polyethylene foam (PE)
- 4 drain holes with plugs

Insulated Container | Typ 660B

ICF660BPEOL5010

Insulated Container | Typ 660G

ICF660GPEOL5010



Accessories



Lid for insulated containers

Optionally, most of our products can be fitted with a matching PUR-insulated lid. These lids are equipped with UV-resistant rubber tensioners. The lids' design allows for stacking with other containers.

lid for insulated container | 1230 x 1030 mm | blue

ICDF123103APUX5010



Foil covers for pallet containers and insulated hygiene containers

The covers are made of tear-resistant polyethylene (PE) and offer a cost-effective yet efficient solution for hygienic sealing, isolating product odors. The stretchable coating allows for easy application and removal.



Rubber tensioners

Strong, UV-resistant rubber tensioners for attaching the lid to the container.



Adapter for insulated containers

Adapter: BCS 56x4 external thread to BSP 2" internal thread.

Adapter for insulated containers | S56x4 außen auf 2" BSP innen | schwarz

ICFZAS56A2BSP1X9005



Threaded plug for insulated containers

Threaded plug with sealing ring for a secure seal of the drain opening. Optionally available with a 3/4" drain hole for connecting a hose or drain valve.

Gewindestopfen for insulated containers | S56x4 | weiß

ICFZGS56X9010



RFID-identification

RFID transmitters enable fast and efficient product identification, facilitating improved inventory management and tracking. If you are interested in this option, please contact us for more information and pricing.

Big Boxes

Our plastic pallet containers are particularly robust and impress with their low weight and high capacity. The containers are a cost-effective investment as they can be used for many years. After use, they can be easily recycled, which underlines their environmental friendliness. Our containers are not only resistant to moisture, but can also be cleaned and disinfected. They are therefore extremely versatile.

Our containers are as individual as their areas of application. Depending on the model, they are available with bottom runner, feet, or wheels. Various colours make it easy to distinguish between them, e.g. by department or area of application. Depending on requirements, the containers are available in closed, perforated, and foldable versions.

Matching plastic lids reliably protect the goods from dirt and moisture. The containers are easily stackable.



AT A GLANCE

- dimensions: 1.200 x 800 mm and 1.200 x 1.000 mm
- dynamic load capacity: up to 750 kg
- standard colours: grey, green, red, blue, yellow, black
- costum colours and individual printing possible
- available as closed or perforated version
- with feet or bottom runners
- made of 100% new HDPE – food-safe
- matching lids are also available
- deliverable also as foldable version
- 4-way container – accessible from all four sides with a pallet truck
- castor set for easy self-assembly sold separately
- resistant to a variety of oils, acids, and alkalis, therefore also perfectly suitable for workshops and production facilities; easy to clean thanks to the completely closed and smooth surface



142



OPTIONALLY AVAILABLE WITH 4 FEET OR 3 BOTTOM RUNNERS



SET OF CASTORS OPTIONALLY AVAILABLE

AVAILABLE IN DIFFERENT COLOURS:



Big Box closed

These closed containers are characterized by their robust construction with closed and smooth walls. Their smooth design makes them easy to clean and to disinfect. The base dimensions in ISO and EURO standards enable the worldwide transport of heavy, bulky goods as well as small, sensitive goods that require special protection during transport. Various configuration options enable cross-industry use for the storage and transport of goods.

	Big Box closed	
	1.200 x 1.000 x 760 mm	1.200 x 800 x 790 mm
Big Box closed with 3 bottom runners grey	BBFIG760SEK3X 7040	BBFEG790SEK3X 7040
Big Box closed with 4 feet grey	BBFIG760SEF4X 7040	BBFEG790SEF4X 7040
lid for Big Box grey	BDFIAOLX 7040	BDFEAOLX 7040
set of castors Big Box	on request	
bottom runner for replacement for Big Box 1200 x 1000 mm centre	BBFZKAIEKPX9005	
bottom runner for replacement for Big Box 1200 x 1000 mm exterior	BBFZKMIKXPX9005	

Range of colours

The Big Boxes are available in different colours. Please choose one of the colours from the list on the right and replace the corresponding digits in the item number with the corresponding colour code from the list to generate the correct item number for your order. Example: In the item number BBFIG790SKOL**7040** „7040“ stands for grey. For a different colour please use one of the following colour codes:

- 1018 yellow
- 3013 red
- 5003 blue

- 6017 green
- 7040 grey
- 9005 black



Big Box perforated

The perforated version made of high-quality plastic impresses with its robustness and large capacity. Our containers are particularly suitable for products that require ventilation, e.g., in the food industry. The ventilation slots prevent condensation and excessive heat build-up. The base dimensions of 1.200 x 1.000 mm enable easy transport with pallet trucks and forklifts. Our standard products are available from stock with no minimum purchase quantity.

Our perforated containers are available with 4 feet or 3 bottom runners in the colours grey and green.

	Big Box perforated 1.200 x 1.000 x 760 mm
Big Box perforated with 3 bottom runners grey	BBFIP760SEK3X7040
Big Box perforated with 4 feet grey	BBFIP760SEF4X7040
lid for Big Box grey	BDFIAOLX7040
set of castors Big Box	on request



BIG BOX FOLDABLE CLOSED



FLAP FOR EASY LOADING AND UNLOADING



SPACE-SAVING FOLDABLE

Big Box foldable

The foldable version made of high-quality plastic impresses with its robustness and large capacity. The containers with a flap make loading and unloading much easier. After use, the container can be stored away in a space-saving manner until its next use. This practical box is the first choice, especially in areas where storage capacity is limited. The optionally available lid reliably protects your goods from environmental influences. Our standard products are available from stock with no minimum purchase quantity.

Please note that the foldable pallet containers 1200 x 800 are not food-safe.

	Big Boxes foldable	
	1.200 x 1.000 mm	1.200 x 800 mm
Big Box foldable closed with 3 bottom runners grey	BBFIG800FEK3X7040-10	BBFEG800FEK3X7040-02
lid for Big Box grey	BDFIAOLX7040	BDFEALX7040

Plastic pallets

Lightweight, inexpensive and reliable – these are the characteristics that every pallet should have from a logistical point of view – and these are precisely the characteristics that are a feature of plastic pallets. Some of our pallets are made from high-quality recycled plastic and can be returned to the raw material cycle after years of use. The special design of a plastic pallet makes it much more robust than wooden pallets. They meet the essential criteria for a pallet and their dimensions allow them to be transported with a pallet truck or forklift. They also impress with their temperature and weather resistance. Unlike conventional wooden pallets, they are resistant to bacteria, acids and various types of chemicals.

Our pallets are available in standard EURO and ISO formats, but can of course also be supplied in special sizes on request.

Individual marking with a logo or serial number, as well as production in RAL colours, is possible. We would be happy to provide you with a quote.



AT A GLANCE:

- dimensions: 800 x 600 mm; 1.200 x 800 mm and 1.200 x 1.000 mm
- version: light, universal, heavy duty and hygiene pallets – food-safe
- with closed or open surface
- with feet or bottom runners
- also as ESD version available (on request)



LIGHT PALLET WITH OPEN SURFACE



UNIVERSAL PALLET ANTHRACITE/BLACK



HEAVY DUTY PALLET ANTHRACITE/BLACK

Plastic pallets

Light pallets

- low self-weight but nevertheless high load capacity
- space-saving nestable
- usable worldwide
- with safety edge
- 100 % recyclable

Universal pallets

- Euro- or ISO-size
- open or closed surface
- load capacity up to 600 kg in a shelf
- dynamic load capacity up to 1.000 kg

Heavy duty pallets

- Euro- or ISO-size
- open or closed surface
- load capacity up to 600 kg in a shelf
- dynamic load capacity up to 1.000 kg

	plastic pallets		
	800 x 600 mm	800 x 1.200 mm	1.000 x 1.200 mm
light pallet open 6 feet black recycled	LPFHO7O130F6OX9005R	-	-
light pallet open 9 feet black recycled	-	LPFEO7O153F9OX9005R	LPFIO7O153F9OX9005R
universal pallet open 3 bottom runners black recycled height: 145 mm	-	UPFEO7O145K3OX9005R	-
universal pallet open 3 bottom runners black recycled height: 150 mm	-	-	UPFIOKO150K3OX9005R
universal pallet open 3 bottom runners black recycled height: 155 mm	-	UPFEO7O155K3OX9005R	-
heavy duty pallet closed 3 bottom runners black recycled	-	SPFEG7O145K3OX9005R	SPFIG7O145K3OX9005R
heavy duty pallet closed 3 bottom runners grey	-	SPFEG7O150K3OX7040	-



HYGIENIC PALLET H1



HYGIENIC PALLET KU GREY



HYGIENIC PALLET KU BLUE

Hygienic pallet

Particularly noteworthy are our for food accredited hygiene pallets, which are quick and easy to clean thanks to their closed construction. Manufactured exclusively from impact-resistant new material, they can be used without hesitation in the food industry. The smooth, non-porous surface prevents the pallets from absorbing moisture and prevents the accumulation of germs and bacteria.

- quick and easy to clean
- very good weather resistance
- food-safe
- suitable for global transport
- with and without safety edge

	hygienic pallets	
	800 x 1.200 mm	1.000 x 1.200 mm
hygienic pallet - closed - 9 feet - blue	HPFEG7G130F9GX5010	HPFIG7G130F9GX5010
hygienic pallet - closed - 3 bottom runners - grey	HPFEG7G160K3GX7040	HPFIG7G160K3GX7040
hygienic pallet - open - 3 bottom runners - grey	H1FEO7O160K3GX7040-M	-
hygienic pallet - closed - 5 bottom runners - grey	-	HPFIG7G160K5GX7040
hygienic pallet - closed - 5 bottom runners - grey - 3 strengthenings	-	HPFIG7G160K5GX7040-3V
hygienic pallet - closed - 5 bottom runners- grey - 5 strengthenings	-	HPFIG7G160K5GX7040-5V



BUCKETS IN DIFFERENT SIZES



BIN 200 LITER

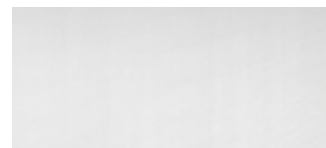

ROLLDOLLY® FOR 75 AND 100 LITER BINS

Buckets and bins

- in sizes of 0.5 up to 200 liter available
- durable, high-quality and robust buckets, bins and lids
- material: PE, food-safe, standard colour: white, individual colour wishes and individual prints possible
- perfectly suitable for the storage and keeping of food, as e.g. fish, meat or milk products, fruits and vegetables, animal feeds, household chemicals, products for house and garden, as e.g. fertilizer, but also for the storage of liquids and much more

	bucket with lids
bucket 0.5 liter, 81 x ø 100 mm	EDF0005OL9010
bucket 1 liter, 131 x ø 122 mm	EDF0010OL9010
bucket 2,5 liter, 157 x ø 162 mm	EDF0025OL9010
bucket 3 liter, 155 x ø 158 mm	EDF0030OL9010
bucket 5 liter, 188 x ø 214 mm	EDF0050OL9010
bucket 10 liter, 267 x ø 250 mm	EDF0100OL9010
bucket 12 liter, 252 x ø 260 mm	EDF0120OL9010
bucket 15 liter, 315 x ø 290 mm	EDF0150OL9010
bucket 20 liter, 320 x ø 310 mm	EDF0200OL9010
bucket 25 liter, 305 x ø 400 mm	EDF0250OL9010
bucket 30 liter, 362 x ø 388 mm	EDF0350OL9010

	bins and lids
bin 35 liter, 410 x ø 390 mm	TF035OL9010
lids for bin 35 liter	TDF035AOL9010
bin 50 liter, 470 x ø 460 mm	TF050OL9010
lids for bin 50 liter	TDF050AOL9010
bin 75 liter, 570 x ø 480 mm	TF075OL9010
lids for bin 75 liter	TDF075AOL9010
bin 100 liter, 670 x ø 520 mm	TF100OL9010
lids for bin 100 liter	TDF100AOL9010
bin 200 liter, 810 x ø 670 mm	TF200OL9010
lids for bin 200 liter	TDF200AOL9010
rolldolly® for 75/100 liter	TRF532250OL7016

Special applications

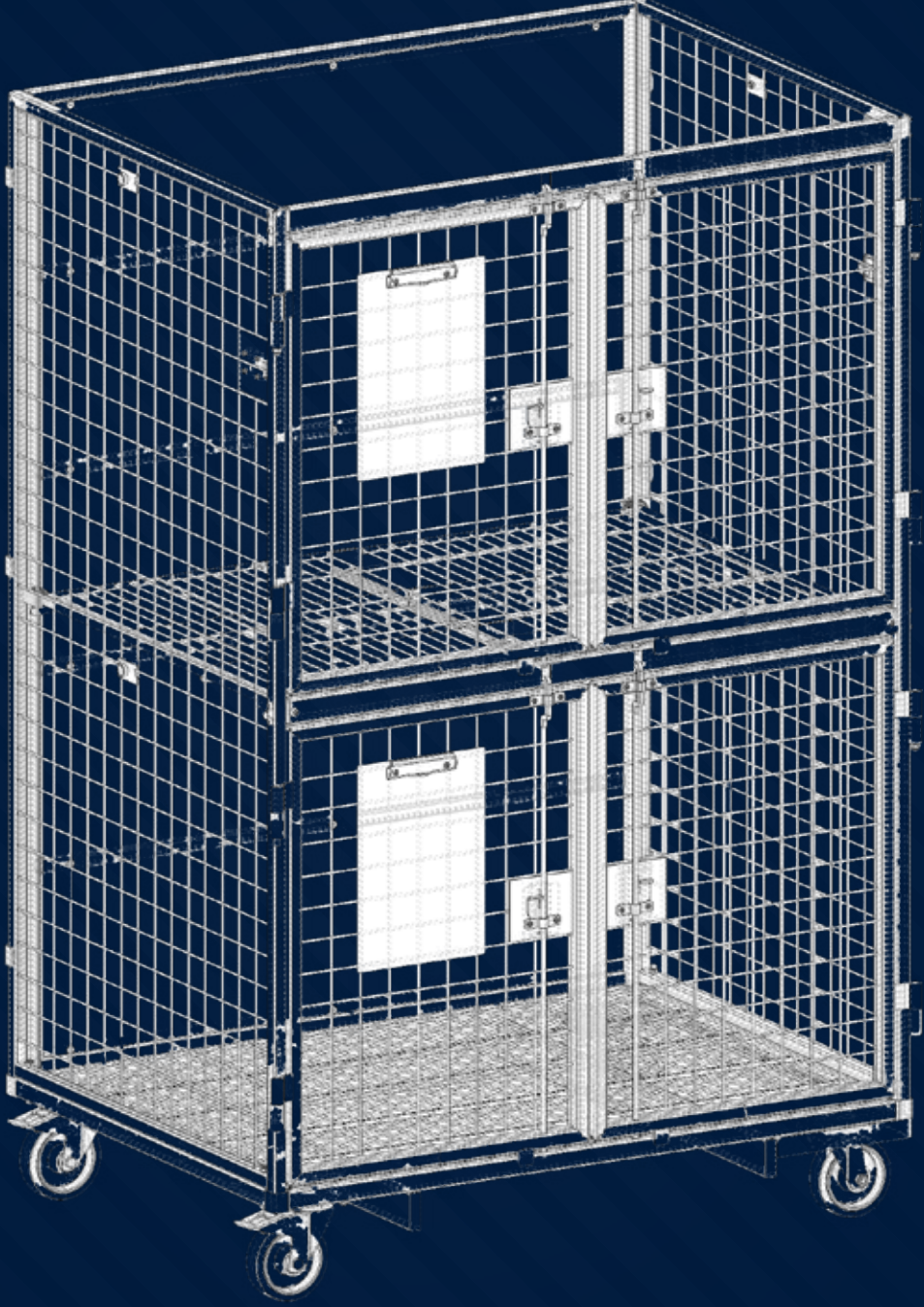

150

Special applications

We always try to react to customer individual requirements as best as we can. Our wide product range offers incredibly many variation possibilities. Often it is sufficient to combine the right components with each other to get a product which fits ones needs. Many products would not be part of todays product range, if we had not always worked on individual solutions. Some of them have made it into our core range and are now available to all of our customers.



Individual
SOLUTIONS
for your
APPLICATION



numerous
ACCESSORIES
for individual
needs

172

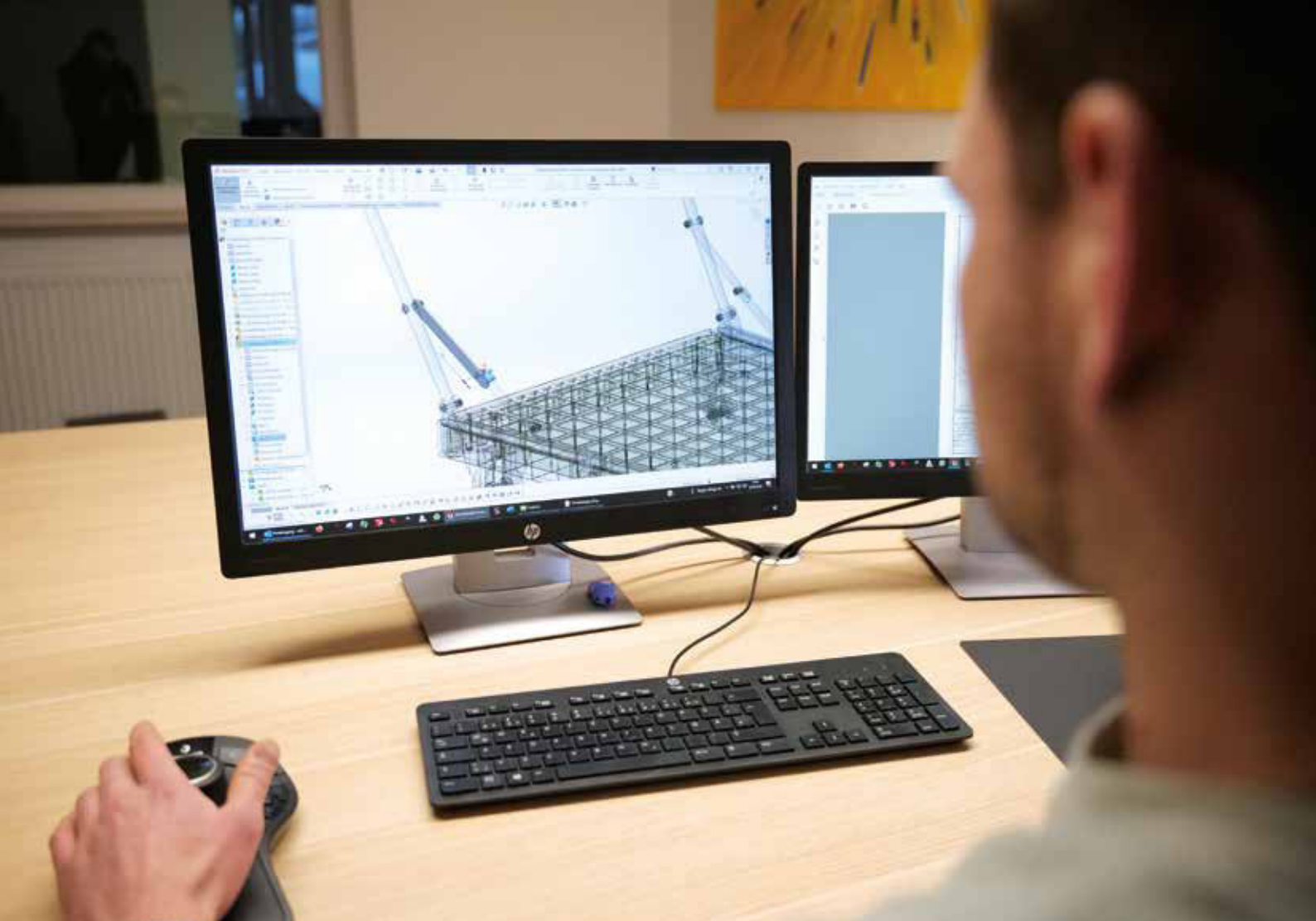

WE CREATE INDIVIDUAL **SPECIAL DESIGNS**

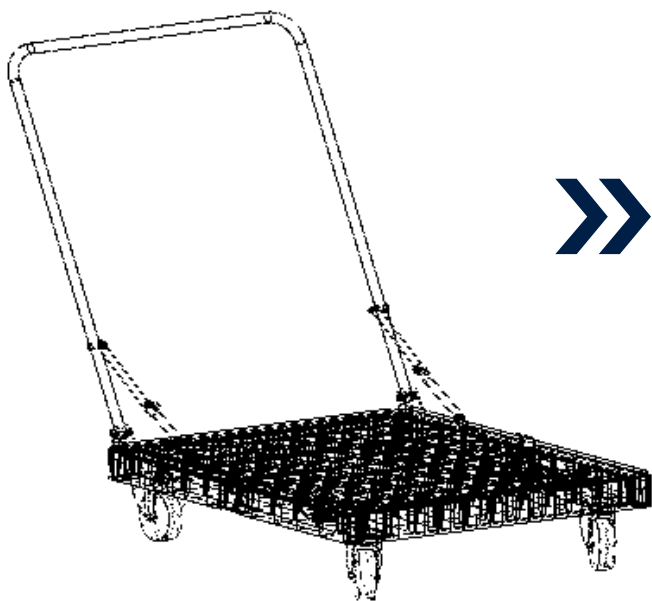

152

The product development starts with a meeting with the customer and a detailed analysis of the application. The product requirements are defined and features are determined. We create a first draft using CAD, which then can be used for the reconciliation with the customer. 3D views quickly provide information as to whether the chosen direction leads to the goal. Once this milestone has been reached, the individual components are designed. These components form the basis for the production. More complex developments start with the construction of a prototype. We accompany the sampling, so that we can optimally consider necessary adjustments. After the final construction is created, the series can be produced.

Even with the individual product development we try to use as many standard components as possible for reaching the best price-performance ratio. Here, for example, we have been using the plastic-joining technology for several years. Existing plastic components, like plastic bases and interme-

Do not compromise!

- ✓ We create a product for you, which is exactly geared to your needs.
- ✓ Parts of our product range can be recombined.
- ✓ Existing products can be adjusted and varied.

mediate shelves, can be cut and put together with new dimensions. If, for example, only the width of the base is reduced, we can still use the standard side panels for the new rolltainer.

Examples for special applications according to the customers' request



Plastic components in special dimensions

The plastic bases and intermediate shelves made of plastic are produced with the injection moulding-procedure, which means liquid plastic is inserted into a predefined form. With this procedure, there are almost no possibilities to influence the dimensions of the components. The dimensions are predetermined through the existing form.

Here, our plastic-joining technology offers new opportunities to adjust the components for specific requirements. The plastic bases or plastic intermediate shelves are cut to the right dimensions. Afterwards the pre-cuts are put together with a stub welding machine. The plastic is welded at the join patch and creates a very stable linkage. With this, we can create new sizes for you, so that you can adjust the rolltainer® even better to your needs.

Feel free to contact us. We are happy to check your needs and advise you on the existing options.

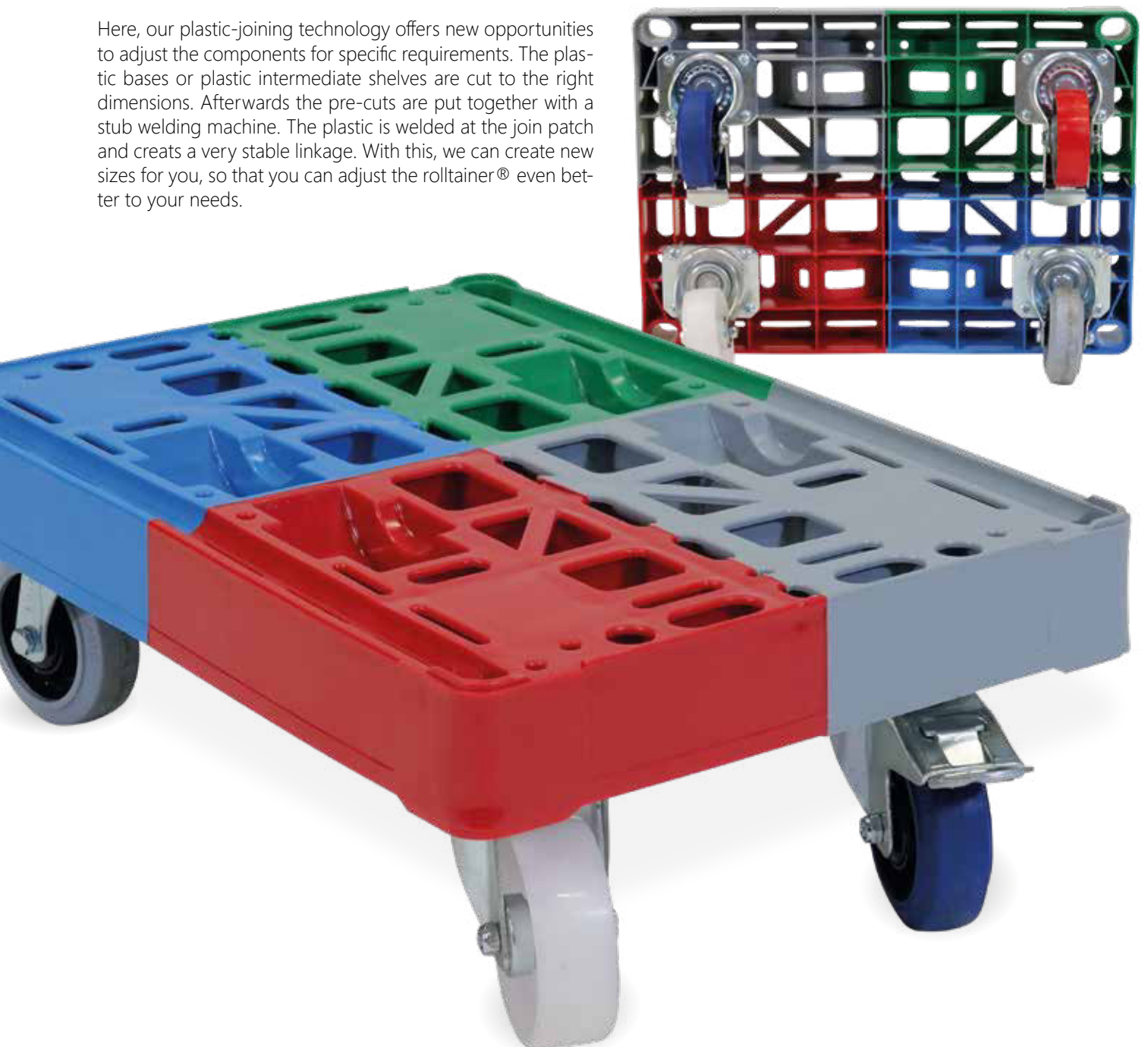

All benefits at a glance

- ✓ individual adjustment to your needs with consistent quality
- ✓ use the versatility of our existing products for your purposes
- ✓ we will find the right solution for your requirements!



Examples for welding technique



Feel free to contact us!

+49 2952 970958-80

WE CREATE BESPOKE

Customised solutions with electric drives



EasyGo Premium Medium

electric drive with 2 x PU wheels, foamed ø 200 mm

- load capacity: 500 kg
- batteries: 20Ah / AGM (The special absorbent glass mat (AGM) absorbs the entire acid in the battery, ensuring a high cycle stability. Thus the battery can be repeatedly charged and discharged without any loss of performance.)
- charger - charging time: 2.5 A, 24V – 6 hours
- driving time up to 10 km (on level ground without incline)
- engine power: 350 W
- weight with battery: 32 kg
- speed infinitely variable: 1 – 5.5 km/h
- external dimensions: 575 x 380 x 230 mm (w x l x h)
- delivery with remote control available for an additional charge



EasyGo One

electric drive with one elastic wheel

- load capacity: 400 kg
- batteries: 9Ah / AGM
- charger - charging time: 2.5 A, 24V – 6 hours
- driving time up to 5 km (on level ground without slope)
- engine power: 250 W
- weight with battery: 10 kg
- speed infinitely variable: 1 – 4.5 km/h
- external dimensions: 780 x 260 x 156 mm (w x l x h)
- delivery with remote control available for an additional charge





Translet Walker

stand-up tractor with 3 x pneumatic tyres ø 260 mm

- load capacity: 125 kg
- pulling force: 750 kg
- batteries: 20 Ah / AGM
- charger - charging time: 7 A, 24 V – 6 hours
- driving time up to 10 km (on level ground without incline)
- speed max. 10 km/h
- turning radius: 750 mm
- engine power: 1.200 W
- weight with battery: 90 kg
- external dimensions: 673 x 935 x 1.270 mm (w x l x h)

Translet Walker

I102313

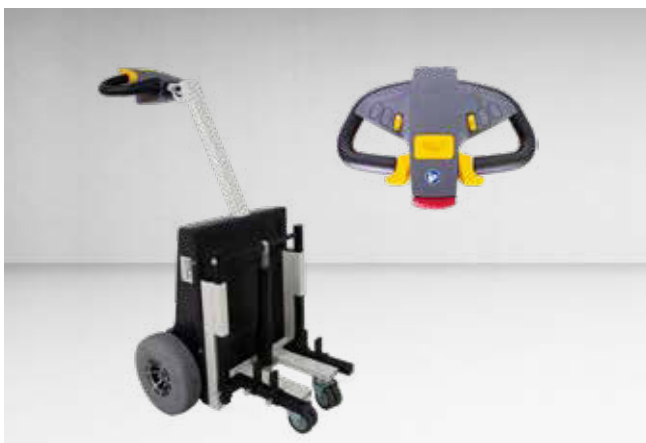

S-Dozer

pulling tractor with pneumatic tyres ø 260 mm

- load capacity: 450 kg
- batteries: 20 Ah / AGM
- charger - charging time: 2.5 A, 24 V – 6 hours
- lifting function with electric linear drive: max. stroke: 150 mm, min. ground clearance: 130 mm
- driving time up to 10 km (on level ground without incline)
- engine power: 350 W
- weight with battery: 90 kg
- speed 3.5 – 6 km/h (turtle / rabbit)
- external dimensions: 600 x 530 x 1.220 mm (w x l x h)
- delivery with remote control available for an additional charge

S-Dozer
pulling tractor with pneumatic
tyres ø 260 mm

I101243

S-Dozer „Spildop 660L“,
pulling tractor with lifting
device and gripping
mechanism wheels

I101244

Transport equipment for trade, crafts, industry and logistics

Whether in the workshop, warehouse, production area, or shipping department: our transport equipment ensures smooth workflows in everyday work. From lightweight trolleys to heavy-duty transport solutions – with us you will find well-designed, robust, and field-tested products for internal transport.



Push bar trolley

- versatile use in the workplace
- easy to maneuver
- robust steel construction
- for boxes, cartons, and containers



Front wall trolley with mesh wall

- safe transport of loose cargo
- good visibility of the load
- stable and durable
- ideal for warehousing and shipping



Warehouse trolley

- order and clarity in material flow
- quick access to small parts
- perfect for order picking
- space-saving and efficient



SHELF TROLLEY HIGH VERSION

All benefits at a glance

- ✓ Proven standard solutions for industrial applications.
- ✓ High-quality workmanship for everyday use.
- ✓ A valuable complement to customized solutions
- ✓ Clear system for efficient material flows.
- ✓ Consulting, delivery, and project support from a single source.
- ✓ Permanently welded design.



ASSEMBLY DOLLY



TABLE TROLLEY TUBE FRAME

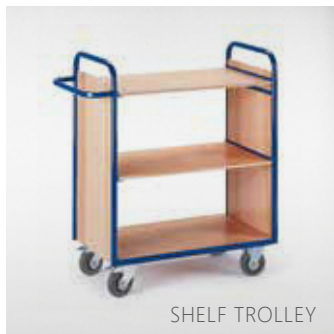

SHELF TROLLEY



TABLE TROLLEY



PALLET CHASSIS



HAND TRUCK WITH SLIDING EDGE



PUSH BAR TROLLEY

Feel free to contact us!

+49 2952 970958-80

Custom made transport solutions for efficient logistics and ergonomic working

Whether in modern high-bay warehouses, specialized manufacturing facilities, or demanding shipping environments: Our transport equipment combines maximum stability with ease of use. From maneuverable standard platform trolleys to custom-designed special constructions.



Steel cylinder trolley 2 x 50 ltr.

- safe transport of gas cylinders
- high stability
- ideal for mobile use on construction sites
- available in various versions for 10, 20 and 50 liter gas cylinders

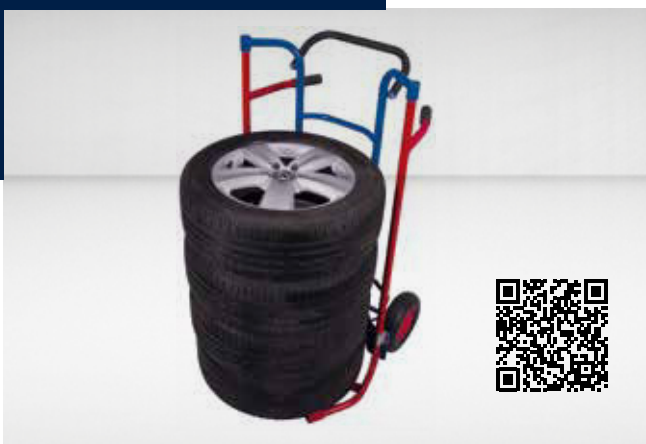

Tire hand truck

- large push handle with soft plastic grip cover
- lever system with hold-open and clamping function via gas springs
- demountable, therefore all parts are replaceable
- wheel weight close to the axle, due to the rearward-curved axle



Hand platform trolley

- order and clarity in material flow
- quick access to small parts
- perfect for order picking
- space-saving and efficient
- permanently welded design



SHELF TROLLEY

All benefits at a glance

- ✓ Proven standard solutions for industrial applications.
- ✓ High-quality workmanship for everyday use.
- ✓ A valuable complement to customized solutions.
- ✓ Clear system for efficient material flows.
- ✓ Consulting, delivery, and project support from a single source.
- ✓ Permanently welded design.

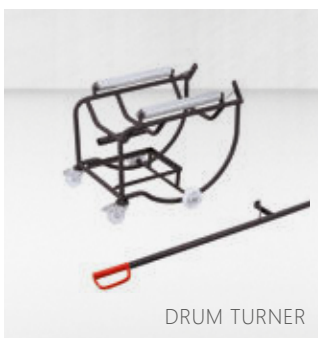

DRUM TURNER



DRUM DOLLY



WIRE MESH
CAGE TROLLEY



HANDBARROW



PANEL TROLLEY



SHELF TROLLEY FOR EUROBOXES



WAREHOUSE TROLLEY

Feel free
to contact us!

+49 2952 970958-80

Wheels & castors



The right choice

What is the best way to transport my goods from A to B? Of course, on wheels. But which castors do I need for my intended purpose? Different influences should be considered when selecting the appropriate castors: load capacity, temperature range, floors, volume, working environment and of course also the price. In the following we would like to give an overview, which can serve as a guide to help you in your decision-making process.

■ 2 or rather 4 swivel castors?

No matter if you choose 2 swivel castors and 2 fixed castors or rather 4 swivel castors, both versions have their right to exist. If you use your rolltainer® for long ways, we recommend the use of 2 swivel and 2 fixed castors, because this ensures a better directional stability and the user does not need to correct the direction of movement all the way. However, if you need to transport the goods through small corridors (e.g.: shopping trolley in the supermarket), the version with 4 swivel castors is the right choice, as you stay flexible in the side movements and you can rotate on a point.

■ When do I need a total brake?

Here, we usually differentiate a total brake, which completely blocks the wheel, from a directional lock, where the wheel still rotates, but where the direction is locked, which means the swivel castor can no longer turn, but „only“ works like a fixed castor. The most common version of locking devices with castors is the total brake (or also double stop). It is important to note that it is not working like a real brake, but as a lock, which only secures the rolltainer® against rolling away. We guarantee the functionality under the following definition:

combination 2 fixed castors – 1 swivel castor – **1 swivel castor with total brake**

- securing of an empty or loaded rolltainer® against rolling away on a basically level surface, but with a slope of max. 2%
- securing of an empty or loaded rolltainer® against rolling away in light winds
- short-term securing of an empty or loaded rolltainer® on truck lifting platforms in combined use with the roll-off protection of the lift

combination 2 fixed – **2 swivel castors with total brake**

- securing of an empty or loaded rolltainer® against rolling away on surfaces with a slope of max. 5%
- securing of an empty or loaded rolltainer® against rolling away in strong winds (does not protect the container against tipping over)
- securing of an empty or loaded rolltainer® on the truck in combination with legally compliant load securing. As far as possible, the securing devices should not be activated in the moving truck.

[The operator is obliged to operate in accordance with the applicable legislation, e.g. the road haulage law.]

■ How do I calculate the load capacity?

When using four castors under a transport trolley, you must always assume that one castor is „hanging“ in the air - due to an uneven floor for example - and cannot contribute to the stability of the trolley. Therefore, the total load capacity of a trolley is always calculated with 3 out of 4 castors. The details of the load capacity on the following pages always refer to the dynamic properties of the respective DIN standards (EN 12530 - 12533) per castor. If you multiply these values by 3, you get the total load capacity of the trolley according to the corresponding DIN standard and its requirements.

■ Which material do I choose for my intended purpose?

Probably the most difficult question which you need to answer for choosing the suitable castors for you, is the question of the material. Each material has different properties and accordingly different advantages and disadvantages as well. Material can be soft or hard, loud or quiet, solid or light and much more. On the following pages we will bring you closer to the advantages of each series and hope to be able to support you with your decision. If you have unanswered questions, please do not hesitate to contact us. On the one hand, we are happy to provide with help and advice due to many years of experience, on the other hand you may also need a special solution, which we would be happy to explain to you in a personal conversation.

The classic ones

The classic castors used for rolltainer® are 108 mm ø castors made of polypropylene (PP) or polyamide (PA). Our PP castors of the series POPO convince through a perfect price-performance-ratio and are the ideal helpers for the daily transport of your goods. When the environmental requirements increase, our PA castors of the series NONO are the right choice. Heavy loads and high as well as low temperatures pose no problem for the castors made of polyamide (PA).



ø 108 mm PP white

wheel center	polypropylene white
tread	polypropylene white
bearing	roller bearing
total height	132 mm
hole pattern	80 x 60 mm
dyn. load capacity	150 kg

swivel castor ø 108 mm	SIP25WC108P0P0R1W
fixed castor ø 108 mm	FIP22WC108P0P0R1W
swivel castor with total brake ø 108 mm	TIP25WC108P0P0R1W

- ✓ flexible everyday helper
- ✓ price-performance-ratio
- ✓ low starting resistance and therefore energy-saving



ø 108 mm PA white

wheel center	polyamide white
tread	polyamide white
bearing	roller bearing
total height	132 mm
hole pattern	80 x 60 mm
dyn. load capacity	200 kg

swivel castor ø 108 mm	SBP25WC108N0N0R1W
fixed castor ø 108 mm	FBP22WC108N0N0R1W
fixed castor strengthened ø 108 mm	FPP65WC108N0N0R1W
closed fixed castor ø 108 mm	FPP74WC108N0N0R1W
swivel castor with total brake ø 108 mm	TBP25WC108N0N0R1W

- ✓ durable and strong allrounder
- ✓ suitable at low and high temperatures
- ✓ available in different colours and special designs

The small and large classic ones

Of course, our classics are also available in different sizes. The features and characteristics are the same as for the 108 mm castors. Larger diameters, however, help to overcome interstices, gaps and small objects more easily. If you are limited by the total height of the rolltainer® or want to save money, you should decide in favour of the smaller wheel diameter.



Ø 100 mm / 125 mm PP white

wheel center polypropylene white
 tread polypropylene white
 bearing roller bearing
 total height 125 mm / 155 mm
 hole pattern 80 x 60 mm
 dyn. load capacity 100 kg / 150 kg

swivel castor Ø 100 mm	SIP25WC100P0P0R1W
fixed castor Ø 100 mm	FIP22WC100P0P0R1W
swivel castor with total brake Ø 100 mm	TIP25WC100P0P0R1W
swivel castor Ø 125 mm	SBP95WC125X0P0R1W
fixed castor Ø 125 mm	FBP92WC125X0P0R1W
swivel castor with total brake Ø 125 mm	TBP95WC125X0P0R1W

- ✓ flexible everyday helper
- ✓ price-performance-ratio
- ✓ low starting resistance and therefore energy-saving



Ø 100 mm / 125 mm PA white

wheel center polyamide white
 tread polyamide white
 bearing roller bearing
 total height 125 mm / 155 mm
 hole pattern 80 x 60 mm
 dyn. load capacity 150 kg / 200 kg

swivel castor Ø 100 mm	SIP25WC100N0N0R1W
fixed castor Ø 100 mm	FIP22WC100N0N0R1W
swivel castor with total brake Ø 100 mm	TIP25WC100N0N0R1W
swivel castor Ø 125 mm	SBP95WC125Y0N0R1W
fixed castor Ø 125 mm	FBP92WC125Y0N0R1W
swivel castor with total brake Ø 125 mm	TBP95WC125Y0N0R1W

- ✓ durable and strong allrounder
- ✓ suitable at low and high temperatures
- ✓ available in different colours and special designs

The noiseless ones

Of course, these castors are not completely noiseless. But our elastic castors of the series R4E1/R4E2 convince through their low-noise running due to their extra soft tread. The high amount of natural rubber ensures a low starting resistance and a durable material even with high load capacities.



Ø 100 mm / 125 mm elastic blue

wheel center polyamide black
 tread elastic 65° Shore A blue
 bearing roller bearing
 total height 125 mm / 155 mm
 hole pattern 80 x 60 mm
 dyn. load capacity 160 kg / 200 kg

swivel castor Ø 100 mm	SBP25WC100R4E1R0N
fixed castor Ø 100 mm	FBP22WC100R4E1R0N
swivel castor with total brake Ø 100 mm	TBP25WC100R4E1R0N
swivel castor Ø 125 mm	SBP35WC125R4E1R0N
fixed castor Ø 125 mm	FBP32WC125R4E1R0N
swivel castor with total brake Ø 125 mm	TBP35WC125R4E1R0N

- ✓ low-noise running on all surfaces
- ✓ sufficient load capacity in the established Basics version
- ✓ also with grey tread as stainless steel version V2A available



Ø 100 mm / 125 mm elastic grey

wheel center polyamide black
 tread elastic 65° Shore A grey
 bearing central ball bearing
 total height 128 mm / 155 mm
 hole pattern 80 x 60 mm
 dyn. load capacity 200 kg / 220 kg

swivel castor Ø 100 mm	SPP21WC100R4E2B34
fixed castor Ø 100 mm	FPP22WC100R4E2B34
swivel castor with total brake Ø 100 mm	TPP21WC100R4E2B34
swivel castor Ø 125 mm	SPP31WC125R4E2B34
fixed castor Ø 125 mm	FPP35WC125R4E2B34
swivel castor with total brake Ø 125 mm	TPP31WC125R4E2B34

- ✓ low-noise running on all surfaces
- ✓ high load capacities in the strong Premium version
- ✓ ball bearing as axle bearing for improved rolling resistance

The tough ones

Our castors of the series N2U6 and M6N2 are exceedingly tough and resilient. The serie N2U6 consists of a tread made of thermoplastic polyurethane (TPU) and a wheel center made of polyamide with a central ball bearing. This serie is also available with roller bearing. TPU is particularly resistant to a lot of acids, oils and fats. The series M6N2 combines the advantages of the PA serie with a noise reduction and the possibility of sideward movement.



∅ 100 mm / 125 mm PA / PU

wheel center	polyamide grey
tread	polyurethane 95° Shore A red
bearing	central ball bearing
total height	125 mm / 155 mm
hole pattern	80 x 60 mm
dyn. load capacity	150 kg / 200 kg

swivel castor ∅ 100 mm	SBP25WC100N2U6B32
fixed castor ∅ 100 mm	FBP22WC100N2U6B32
swivel castor with total brake ∅ 100 mm	TBP25WC100N2U6B32
swivel castor ∅ 125 mm	SBP35WC125N2U6B32
fixed castor ∅ 125 mm	FBP32WC125N2U6B32
swivel castor with total brake ∅ 125 mm	TBP35WC125N2U6B32

- ✓ particular resistance to acids, oils and fats
- ✓ high load capacities in various temperature ranges
- ✓ noise-reduced running due to the slightly elastic tread



∅ 100 mm / 125 mm PA Sandwich

wheel center	polyamide grey with elastic ring
tread	polyamide grey
bearing	roller bearing
total height	128 mm / 155 mm
hole pattern	80 x 60 mm
dyn. load capacity	160 kg / 200 kg

swivel castor ∅ 100 mm	SPP21WC100M6N2R32
fixed castor ∅ 100 mm	FPP25WC100M6N2R32
swivel castor with total brake ∅ 100 mm	TPP21WC100M6N2R32
swivel castor ∅ 125 mm	SPP31WC125M6N2R32
fixed castor ∅ 125 mm	FPP35WC125M6N2R32
swivel castor with total brake ∅ 125 mm	TPP31WC125M6N2R32

- ✓ durable alternative with high load capacities
- ✓ noise-reduced running due to the absorbing inner elastic ring
- ✓ sideward movement, e.g. on a truck, possible without any problems

The Light ones

If the goods which need to be transported do not have a high self-weight and you nevertheless want to have a noise-reduced running, our TPR castors of the series P2W2 and P2G2 are the best choice. Here design meets functionality. These castors are mainly used indoors and, thanks to their elastic surface, ensure that your internal transport runs smoothly or that your goods are presented in an attractive way.



Ø 100 mm PP / TPR

wheel center	polypropylene grey
tread	thermopl. rubber 95° Shore A grey
bearing	roller bearing
total height	125 mm
hole pattern	80 x 60 mm
dyn. load capacity	100 kg

swivel castor Ø 100 mm	SBP26WC100P2W2R1W
fixed castor Ø 100 mm	FBP22WC100P2W2R1W
swivel castor with total brake Ø 100 mm	TBP25WC100P2W2R1W

- ✓ noise-reduced running on all surfaces
- ✓ sufficient load capacity in the established Basics version
- ✓ established bestseller as castor under the rolldolly®



Ø 100 mm / 125 mm PP / TPR

wheel center	polypropylene grey
tread	thermopl. rubber 65° Shore A grey
bearing	central ball bearing
total height	125 mm / 155 mm
hole pattern	80 x 60 mm
dyn. load capacity	135 kg / 165 kg

swivel castor Ø 100 mm	SBP26WC100P2G2B32
fixed castor Ø 100 mm	FBP22WC100P2G2B32
swivel castor with total brake Ø 100 mm	TBP25WC100P2G2B32
swivel castor Ø 125 mm	SBP35WC125P2G2B32
fixed castor Ø 125 mm	FBP32WC125P2G2B32
swivel castor with total brake Ø 125 mm	TBP35WC125P2G2B32

- ✓ low-noise running on all surfaces
- ✓ extraordinary design
- ✓ ball bearing as axle bearing for improved rolling resistance

The strong ones

Special situations require special actions! If you have not found the right product by now, you certainly will find it with our strong alternatives, the series AAE2 and AAU5 with a wheel center made of aluminium. If four castors are used, goods with up to 900 kg can be transported. Both series, the elastic as well as the cast polyurethane persuade with different advantages. Convince yourself!



Ø 100 mm / 125 mm alu / elastic

wheel center	aluminium
tread	elastic 65° Shore A grey
bearing	double ball bearing
total height	128 mm / 155 mm
hole pattern	80 x 60 mm
dyn. load capacity	200 kg / 250 kg

swivel castor Ø 100 mm	SPP37WC100AAE2D0N
fixed castor Ø 100 mm	FPP33WC100AAE2D0N
swivel castor with total brake Ø 100 mm	TPP37WC100AAE2D0N
swivel castor Ø 125 mm	SPP37WC125AAE2D0N
fixed castor Ø 125 mm	FPP33WC125AAE2D0N
swivel castor with total brake Ø 125 mm	TPP37WC125AAE2D0N

- ✓ is able to transport goods up to 750 kg!
- ✓ low-noise running due to the soft elastic tread
- ✓ does not leave any marks even at high loads



Ø 100 mm / 125 mm alu / PU

wheel center	aluminium
tread	polyurethane 92° Shore A brown
bearing	double ball bearing
total height	128 mm / 155 mm
hole pattern	80 x 60 mm
dyn. load capacity	250 kg / 300 kg

swivel castor Ø 100 mm	SPP37WC100AAU5D0N
fixed castor Ø 100 mm	FPP33WC100AAU5D0N
swivel castor with total brake Ø 100 mm	TPP37WC100AAU5D0N
swivel castor Ø 125 mm	SPP37WC125AAU5D0N
fixed castor Ø 125 mm	FPP33WC125AAU5D0N
swivel castor with total brake Ø 125 mm	TPP37WC125AAU5D0N

- ✓ is able to transport goods up to 900 kg!
- ✓ particular resistance to acids, oils and fats
- ✓ extremely robust to external influences / impacts

The agile ones

The physical stress of the employee when transporting and processing the goods plays an increasingly important role in the evaluation of the working environment and ergonomics today. For this reason we developed two wheels (series N4B5 and series AAB5) which convince with huge flexibility and low resistance even at high loads. Through the spherical and small contact face of the wheel on the floors, friction and resistance are minimized and contribute to a simplification of the handling of the goods.



ø 100 mm / 125 mm PU brown

wheel center polyamide black
 tread polyurethane 92° Shore A brown
 bearing ball bearing
 total height 128 mm / 155 mm
 hole pattern 80 x 60 mm
 dyn. load capacity 200 kg / 250 kg

swivel castor ø 100 mm	SPP21WC100N4B5B34
fixed castor ø 100 mm	FPP25WC100N4B5B34
swivel castor with total brake ø 100 mm	TPP21WC100N4B5B34
swivel castor ø 125 mm	SPP31WC125N4B5B34
fixed castor ø 125 mm	FPP35WC125N4B5B34
swivel castor with total brake ø 125 mm	TPP31WC125N4B5B34

- ✓ ergonomic features even at high loads
- ✓ noise-reduced running due to the resilience of the polyurethane
- ✓ particular resistance to acids / oils / fats



ø 100 mm / 125 mm PU brown

wheel center aluminium
 tread polyurethane 92° Shore A brown
 bearing double ball bearing
 total height 128 mm / 155 mm
 hole pattern 80 x 60 mm
 dyn. load capacity 250 kg / 300 kg

swivel castor ø 100 mm	SPP27WC100AAB5D39
fixed castor ø 100 mm	FPP23WC100AAB5D39
swivel castor with total brake ø 100 mm	TPP27WC100AAB5D39
swivel castor ø 125 mm	SPP37WC125AAB5D39
fixed castor ø 125 mm	FPP33WC125AAB5D39
swivel castor with total brake ø 125 mm	TPP37WC125AAB5D39

- ✓ ergonomic features even at high loads
- ✓ noise-reduced running due to the resilience of the polyurethane
- ✓ particular resistance to acids / oils / fats

The rust-free ones

Some business areas require the use of rust-free material like plastic or stainless steel. Even for these cases we have suitable solutions for you. The housings of our stainless steel castors of the series N0N0 & N2U6 are made of V2A (AISI 304), hence they are corrosion-resistant, weatherproof, durable, heat resistant and in addition also very hygienic.



Ø 100 mm / 125 mm PA white

wheel center tread	polyamide white
bearing	polyamide white
total height	stainless steel plain bearing
hole pattern	128 mm / 155 mm
dyn. load capacity	80 x 60 mm
	150 kg / 200 kg

swivel castor Ø 100 mm	SIP26SC100N0N0L0N
fixed castor Ø 100 mm	FIP22SC100N0N0L0N
swivel castor with total brake Ø 100 mm	TIP26SC100N0N0L0N
swivel castor Ø 125 mm	SIP36SC125N0N0L0N
fixed castor Ø 125 mm	FIP32SC125N0N0L0N
swivel castor with total brake Ø 125 mm	TIP36SC125N0N0L0N

- ✓ rust-free version for a durable use
- ✓ durable and strong allrounder
- ✓ suitable at low and high temperatures



Ø 100 mm / 125 mm PA / PU red

wheel center tread	polyamide grey
bearing	thermopl. polyurethane 95° Shore A red
total height	stainless steel roller bearing
hole pattern	128 mm / 155 mm
dyn. load capacity	80 x 60 mm
	150 kg / 200 kg

swivel castor Ø 100 mm	SIP26SC100N2U6Q0N
fixed castor Ø 100 mm	FIP22SC100N2U6Q0N
swivel castor with total brake Ø 100 mm	TIP26SC100N2U6Q0N
swivel castor Ø 125 mm	SIP36SC125N2U6Q0N
fixed castor Ø 125 mm	FIP32SC125N2U6Q0N
swivel castor with total brake Ø 125 mm	TIP36SC125N2U6Q0N

- ✓ rust-free version for a durable use
- ✓ particular resistance to acids / oils / fats
- ✓ noise-reduced running due to the slightly elastic tread

Accessories



Accessories

Choose the appropriate supplements for your rolltainer® or nestainer® out of the various accessories. Use protective covers to protect your goods or use our safety handle tainergrip® for your own protection. Secure the goods with the innovative gummitex® straps or establish order in your day-to-day business with the help of intermediate shelves. The opportunities are not infinite but numerous. Make your choice on the following pages.

The **RIGHT**
ACCESSORIES
available for every
requirement



**IMPROVE
YOUR
CONTAINER**
according to your
wishes

Securing grid for rolltainer®

Although a roll container protects the goods better than an ordinary pallet and accessories like straps bring additional safety, still a lot of disposable packaging in the form of stretch foil is used. With our securing grid this is no longer necessary. An important step to more sustainability.

TECHNICAL HIGHLIGHTS

- solid mesh with 8 mm thick frame made of wire and two hinges, surface: galvanized blue, Cr 3, Cr 3
- flexibility and adaptability through a new developed double hinge
- it is secured with two straps (textile strap or gummitex®)
- the compression of empties and their return take place as before



The securing grids can be mounted on the side panels with \varnothing 22 mm round tube with minimum effort. No drilling or similar work necessary.

Optionally, the plastic hinge can be mounted below the horizontal flat bar. We offer an additional pipe clamp for this purpose, which serves as a hinge support.

	securing grid
usable height 1350	SGK1220580S0B5C
usable height 1450	SGK1320580S0B4C

Our
STRAPS
can be found on
PAGE 185



A sheet metal board is welded to the securing grid. Here you will find space for barcode labels or your company logo.

securing grid for usable height 1350

- 580 x 1.220 mm (w x h)
- frame made of \varnothing 8 mm wire, circumferential
- \varnothing 5 mm wire, 112 x 118 mm, 4 x vertical, 9 x horizontal
- sheet metal board 107 x 116 x 1.5 mm
- ca. 3.5 kg

securing grid for usable height 1450

- 580 x 1.320 mm (w x h)
- frame made of \varnothing 8 wire, circumferential
- \varnothing 5 wire, 112 x 118 mm, 4 x vertical, 10 x horizontal
- sheet metal board 107 x 116 x 1.5 mm
- ca. 3.7 kg



The overhead stacking is also possible with mounted securing grids.



Sustainability and climate protection

Alternatives to stretch foil

Stretch foil is often used by users of the two- and three-sided rolltainer® for load securing and protecting stored goods. To reduce plastic waste in this area, a textile securing cover and a securing plate have been added to the product range as new, environmentally friendly options, in addition to the existing securing grid. This is an important step towards sustainability and reduced resource consumption.

The three alternatives are easy to install and use. The familiar securing grid is attached to the side panel on one side using double hinges made of high-quality plastic and then secured with tension straps. When not in use, the securing grid can be folded against the side panel and secured there with the tension straps.

The textile door is made of PVC coated fabric and reinforced with fiberglass rods and is installed in the same way as the securing grid. In addition to the option of opening the cover like a door and folding it to the side, it can also be folded horizontally in half. This allows, for example, access to items only from the upper part of the roll container while keeping the goods at the bottom secure.

The Roll-Safe securing plates are thin, twin-wall sheets. They are attached to the side panels either on both sides using tension straps with hooks, or on one side with hinged straps, allowing the Roll-Safe panels to be opened like a door.

Securing grid



Textile doors



Roll-Safe securing plate



tainerlift for rolltainer®

version:

- liftable and lowerable U-shaped construction made of laser-cut and edged sheet steel
- lifting height 22 mm
- suitable for rolltainer, wheels ø 100 mm (with adapter for wheels ø 108 and 125 mm)
- lifting handle made of steel tube ø 25 x 2 x 1.300 mm
- 4 x wheels ø 80 mm, PA
- surface: galvanized blue, Cr 3, Cr 3
- load capacity: 250 kg



Watch the product video

Scan the QR-Code to see how it works.

Flexibly adaptable: one tool for different wheel diameters

The tainerlift is a tool for loading and unloading standard roll containers laterally.

An innovative lever system allows for the easy lifting and movement of heavy loads. The lifting force acts on the two fixed casters of the roll containers, quickly lifting them and enabling easy lateral movement.

In particular, the tainerlift now allows roll containers with rubber and elastic casters to be moved laterally and loaded in a space-optimized manner.

The Tainerlift can be adapted to different clearance heights and wheel diameters using an adapter plate. For quick changeovers between different roll containers with varying clearance heights and wheel diameters (ø 108 and 125 mm), we offer a foldable adapter plate.



tainerlift for rolltainer®

ground clearance

tainerlift ME, 675 mm, lifting 22 mm, for rolltainer® F10 ø 100 mm, Cr 3

↑↓ 120 mm

TLA67522KC004

↑↓ 128 mm or 150 mm

adapter plate screwable, tainerlift ME, 659 x 60 mm, Cr 3

TLAA65960KC004

adapter plate foldable, tainerlift ME, 688 x 28 mm, Cr 3

TLAA68828KC004

Accessories protective covers



One-way cover for rolltainer® 724 x 815 mm

- Usable as rain protection and dust protection

usable height 1.460 mm | transparent

EPA14600000

usable height 1.650 mm | transparent

EPA16500000



One-way cover for rolltainer® 724 x 815 mm

- Usable as rain protection and dust protection

usable height 1.460 mm | milky-white

EPA14609010

usable height 1.650 mm | milky-white

EPA16509010



One-way cover for rolltainer® 724 x 815 mm

- Usable as rain protection and dust protection

usable height 1.460 mm | black

EPA14609005

Personalize

the cover with your logo

The protective cover made of PE-woven fabric can be personalized. We are happy to place a patch with your logo or other requested information on the cover.

Feel free to contact us, we are happy to advise you!



Protective cover for rolltainer® 724 x 815 mm

- protective cover made of PE-woven fabric grey
- both head sides can be opened completely with 2 sewn-in zippers, allowing the roll container to be opened even with the cover on
- usable as rain protection, visual and theft protection
- for repeated use, very solid version
- prints on the cover possible on request

usable height 1.460 mm

AHA14609010

usable height 1.650 mm

AHA16509010



Protective cover for nestainer® 3-sided 1450 / 1550

- dimensions ca. 735 x 825 x 1.560 mm (w/d/h)
- made of PE-woven fabric
- colour: light grey
- one head side (735er width) can be opened with 2 sewn-in zippers

usable height 1.560 mm

AHA15309010



Thermal cover for rolltainer® 724 x 815 mm

- short-termed thermal protection or protection against cold for roll containers 724 x 815 mm
- made of air bubble film (3 mm) with one-sided alu steamed polyester film with tread ply
- average heat conductivity 0,0344 l [W/mK]
- thermal resistivity 0,09 R [m²K/W], heat trasmission value 11,46 k [W/m²K]
- both head sides can be opened completely with 2 sewed zips, therefore the roll container can be opened as well in spite of the superimposed cover

usable height 1.460 mm

THA14609006

Accessories tainergrip®

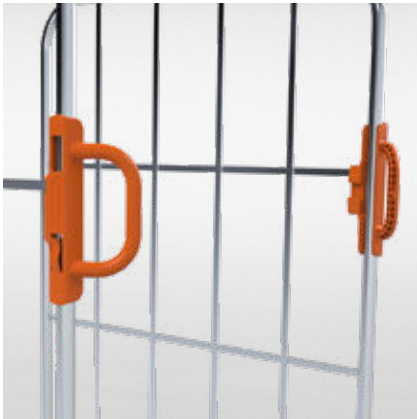

tainergrip® orange for rolltainer®, unmounted version for side panel with flat bars

- plastic handle set for roll containers, consisting of two handles
- version for attaching to side panels with flat bars
- ergonomically shaped handle
- material: PA orange

handle set KU orange for rolltainer®

F90A01PAF2004S2

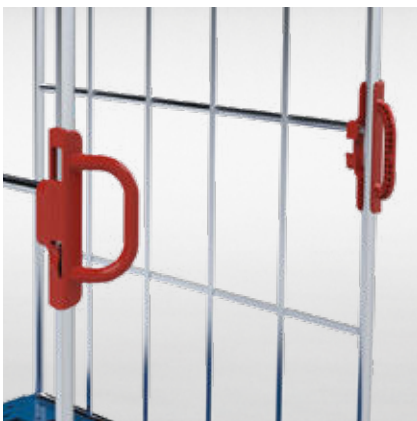

tainergrip® red for rolltainer®, unmounted version for side panel with tube

- plastic handle set for roll containers, consisting of two handles
- version for attaching to side panel with tube
- ergonomically shaped handle
- material: PA red

handle set KU red for rolltainer®

F90A00PAQ3000S2



tainergrip® red for steel roll containers, version for permanent installation

- plastic handle set for roll containers for permanent installation, consisting of two handles
- easy assembling, for all side panels made of round tube \varnothing 22 mm and square pipe 22 x 22 mm
- ergonomically shaped handle
- material: PA red

handle set KU red for steel roll containers

F90A02PAV3000S2M

SAFETY AT WORK IS A TOP PRIORITY

Through the mounted handles you have on the one hand a better possibility to grab the roll container and therefore get a better handling, on the other hand the safety distance to the roll container is extended and you avoid bruises and abrasions. Safe and effective work is guaranteed. A big advantage of the trainergrip® is the quick and easy assembling and thus a smooth workflow.



Handle set ME, Cr 3, for steel roll containers with panels made of round tube \varnothing 22 mm

- easy assembling, for all side panels made of round tube \varnothing 22 mm
- set = two handles incl. assembling material
- surface: galvanized blue, Cr 3, Cr 3
- retrofitting possible

handle set ME, Cr 3 for steel roll containers
round tube

S5ZUBF001



Handle set ME, Cr 3, for steel roll containers with panels made of square pipe 22 x 22 mm

- easy assembling, for all side panels made of square pipe 22 x 22 mm
- set = two handles incl. assembling material
- surface: galvanized blue, Cr 3, Cr 3

handle set ME, Cr 3 for steel roll containers
square pipe

S5ZUBF001

Accessories extensions

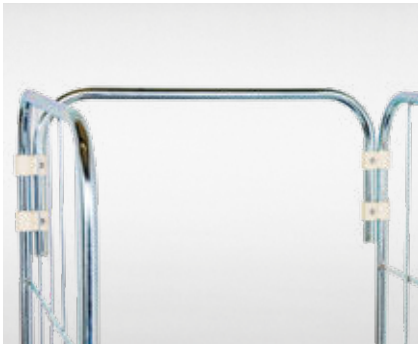

Back panel frame ME, for rolltainer® 724 x 815 mm, Cr 3

- stability frame made of \varnothing 22 mm round tube, incl. four plastic clamps, screws and nuts as well as two end plugs
- surface: galvanized blue, Cr 3

back panel frame ME

MSR300650DMC030



Clothes rail ME, Cr 3, for rolltainer® 724 x 815 mm

- bar made of round tube \varnothing 22 mm
- mounting on one side with plastic clamp and screw
- surface: galvanized blue, Cr 3

clothes bar ME

SK673C



Document holder KU, for rolltainer® side panel, retrofittable

- document holder made of plastic PE
- easy assembling through clamping at the side panel
- dimension: 270 x 160 mm

document holder KU red

KATA3000

document holder KU blue

KATA5010



Document holder KU blue, without foot, retrofittable

- document holder made of plastic PE gentian blue similar to RAL 5010
- version for 4 vertical flat bars
- dimension: 225 x 160 mm

document holder KU blue, without foot

KATAUTOF5010



Picking board with clipboard, Cr 3

- metal board made of sheet steel, type DIN A4
- with metal clamp for attaching documents
- surface: galvanized blue, Cr 3

picking board with clipboard

MKTEC01



Picking board with clipboard, Cr 3, inclinable

- metal board made of sheet steel, type DIN A4
- with steel clamp for attaching documents
- wire attachment in the back for inclination
- surface: galvanized blue, Cr 3

picking board with clipboard, inclinable

MKTKC02

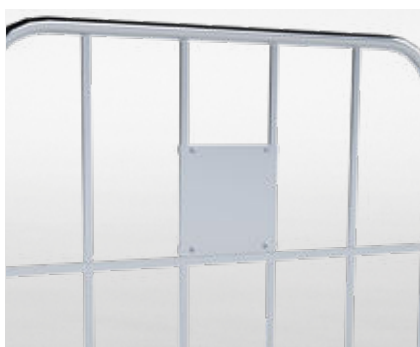

Sheet metal board for rolltainer® side panel, Cr 3, retrofitable

- retrofittable sheet metal board for the standard side panels of the roll containers, surface: galvanized blue, Cr 3
- easy assembling through clamping and riveting at the side panels
- dimension: 160 x 166 mm

sheet metal board for side panels of roll containers

BTK160166CM



Sheet metal board with laser writing, Cr 3, retrofitable

- with individual laser engraving
- retrofittable sheet metal board for the standard side panels of the roll containers, surface: galvanized blue, Cr 3
- easy assembling through clamping and riveting at the side panels
- dimension: 160 x 166 mm

sheet metal board

Accessories extensions



Drawbar and coupling set, Cr 3, for roll containers with plastic base, 724 x 815 and 682 x 815 mm

- adapter cassette with welded coupling mandrel made of solid material \varnothing 25 mm
- ideal for building a tugger train
- suitable for all roll containers with plastic base
- drawbar with double torsion spring, as u-profile ca. 520 x 50 mm, hole dimension \varnothing 30 mm
- surface: galvanized blue, Cr 3

drawbar and coupling set,
for roll containers with plastic base

FDSKSC



Drawbar and coupling set, Cr 3, for steel roll containers 800 x 1200 mm and 950 x 1350 mm

- drawbar made of flat bars 8 mm, length 390 mm
- hole dimension 26 mm, equipped with spring technique
- suspension usable for tube 40 x 20 mm or 50 x 20 mm
- coupling made of solid material \varnothing 20 mm, ca. 80 mm length
- surface: galvanized blue, Cr 3

drawbar and coupling set, for steel roll
containers 800 x 1200 mm and 950 x 1350 mm

FDSF20C



Compactor for plastic film, Cr 3, for roll containers 724 x 815 mm

- auxiliary equipment for the collection and compression of packaging foils as insert in roll containers (724 x 815 mm)
- through the opening, packing films can be collected and effectively compacted
- surface: galvanized blue, Cr 3

compactor for plastic film

FVDKDMC01



Forklift infeed lugs for steel roll containers

- safe transport with a forklift, for steel roll container type 800 x 1200 / 950 x 1350
- dimensions: 190 x 35 mm, entry height: 90 mm
- two drilled holes (\varnothing 8 mm) for screwing to the frame
- surface: galvanized blue, Cr 3

forklift infeed lugs for steel roll containers

MKUF18090C



Rubber strap, black

- dimension: 530 x 38 mm
- max. recommended span length 750 mm
- colour black, hook: galvanized blue, Cr 3

rubber strap, 2 hooks dimension: 530 x 38 mm	B454001
rubber strap, 1 hook / 1 loop dimension: 530 x 38 mm	B454002



gummitex®, dark grey

- textile strap with elastic
- max. recommended span length 750 mm
- colour: dark grey, hook: galvanized blue, Cr 3

gummitex®, 1 hook / 1 loop, without logo, dimension: 50 x 560 mm	E150001BL
gummitex®, 2 hooks, without logo, dimension: 50 x 520 mm	E150002BL

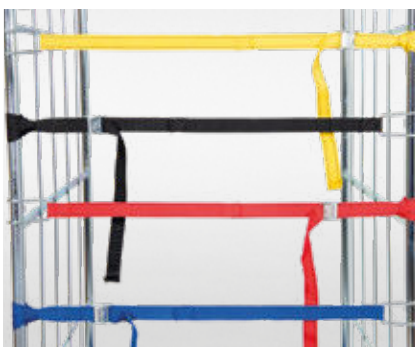

Textile strap with sewn-in elastic strap, 1 clamp lock / 1 hook

- two elastic textile straps made of PP with a hook and a clamp lock
- dimension: 1.050 x 25 mm, max. recommended span length 800 mm

yellow	E459960
black	E459966
red	E459961
blue	E459965

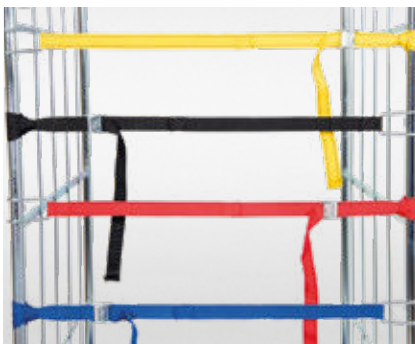

Textile strap, 1 clamp lock / 1 hook

- textile strap with a hook and a clamp lock
- dimension: 1.050 x 25 mm, max. recommended span length 800 mm

yellow	E459940
black	E459943
red	E459941
blue	E459945

rolltainer® intermediate shelves

assignment of loose intermediate shelves in the rolltainer®		intermediate shelf 716 x 812 (RB 2-sided 724)	intermediate shelf 716 x 762 (RB2- 3-sided 724)	intermediate shelf 716x 762 (2- 3 sided 724) rec.	intermediate shelf 716 x 712 (RB 4-sided 724)	intermediate shelf 716x 762 (4- sided 724) rec.	intermediate shelf 674 x 812 (RB 2-sided 682)	intermediate shelf 674 x 762 (RB 3-sided 682)	intermediate shelf 674 x 712 (RB 4-sided 682)
		F70A02PEF33000	E70A23PEF33000	E70A23RCF39005	E70A04PEF33000	E70A04RCF39005	E70B02PEF33000	E70B03PEF33000	E70B04PEF33000
rolltainer® with plug-in system ▶ in the catalogue on page 6	KB2A50101350CS01101V KB2A50101450CS02101V KB2A50101650CS14101V	✓	✓	✓	(✓)	(✓)			
rolltainer® 1350 QP 2-sided ▶ in the catalogue on page 13	KB2A501013505010S01101	✓	✓	✓	(✓)	(✓)			
rolltainer® 1450 QP 2-sided ▶ in the catalogue on page 13	KB2A501014505010S02101	✓	✓	✓	(✓)	(✓)			
rolltainer® 1350 QP 3-sided ▶ in the catalogue on page 13	KB3A501013505010S01101		✓	✓	(✓)	(✓)			
rolltainer® 1450 QP 3-sided ▶ in the catalogue on page 13	KB3A501014505010S02101		✓	✓	(✓)	(✓)			
rolltainer® 1350 QV 2-sided ▶ in the catalogue on page 14	KB2A50101350CS01101	✓	✓	✓	(✓)	(✓)			
rolltainer® 1450 QV 2-sided ▶ in the catalogue on page 14	KB2A50101450CS02101	✓	✓	✓	(✓)	(✓)			
rolltainer® 1350 QV 3-sided ▶ in the catalogue on page 14	KB3A50101350CS01101		✓	✓	(✓)	(✓)			
rolltainer® 1450 QV 3-sided ▶ in the catalogue on page 14	KB3A50101450CS02101		✓	✓	(✓)	(✓)			
rolltainer® 1350 QV 4-sided ▶ in the catalogue on page 14	KB4A50101350CS01101				✓	✓			
rolltainer® 1450 QV 4-sided ▶ in the catalogue on page 14	KB4A50101450CS02101				✓	✓			
rolltainer® 682 1460 2-sided ▶ in the catalogue on page 26	KB2B50101460CS03101						✓	(✓)	(✓)
rolltainer® 682 1460 3-sided ▶ in the catalogue on page 26	KB3B50101460CS03101							✓	(✓)
rolltainer® 682 1500 F 2-sided ▶ in the catalogue on page 29	KB2B50101500HDS00101								
rolltainer® 682 1500 F 3-sided ▶ in the catalogue on page 29	KB3B50101500HDS00101								
rolltainer® 682 1500 F 4-sided ▶ in the catalogue on page 29	KB4B50101500HDS00101								
rolltainer® 675 1460 2-sided ▶ in the catalogue on page 30	KB2D50101460CS03101						✓	(✓)	(✓)
rolltainer® 675 1460 3-sided ▶ in the catalogue on page 30	KB3D50101460CS03101							✓	(✓)
rolltainer® 1460 FV 2-sided ▶ in the catalogue on page 16	KB2A50101460CS03101	✓	✓	✓	(✓)	(✓)			
rolltainer® 1650 FV 2-sided ▶ in the catalogue on page 17	KB2A50101650CS04101	✓	✓	✓	(✓)	(✓)			
rolltainer® 1460 FV 3-sided ▶ in the catalogue on page 16	KB3A50101460CS03101		✓	✓	(✓)	(✓)			
rolltainer® 1650 FV 3-sided ▶ in the catalogue on page 17	KB3A50101650CS04101		✓	✓	(✓)	(✓)			

✓ suitable combination
(✓) suitable combination with restrictions

rolltainer® intermediate shelves

assignment of loose intermediate shelves in the rolltainer®		intermediate shelf 716 x 812 (RB 2-sided 724)	intermediate shelf 716 x 762 (RB2- 3-sided 724)	intermediate shelf 716x 762 (2- 3 sided 724) rec.	intermediate shelf 716 x 712 (RB 4-sided 724)	intermediate shelf 716x 762 (4- sided 724) rec.	intermediate shelf 674 x 812 (RB 2-sided 682)	intermediate shelf 674 x 762 (RB 3-sided 682)	intermediate shelf 674 x 712 (RB 4-sided 682)
		F70A02PEF33000	E70A23PEF33000	E70A23RCF39005	E70A04PEF33000	E70A04RCF39005	E70B02PEF33000	E70B03PEF33000	E70B04PEF33000
rolltainer® 1460 FV with one foldable front panel 4-sided ▶ in the catalogue on page 16	KB4A50101460CS03101				✓	✓			
rolltainer® 1650 FV with one foldable front panel 4-sided ▶ in the catalogue on page 17	KB4A50101650CS04101				✓	✓			
rolltainer® 1650 FV with two pivota- ble front panels 4-sided ▶ in the catalogue on page 17	KB4A50101650CS04201				✓	✓			
rolltainer® 1460 FV with one pivotable front panel 4-sided ▶ in the catalogue on page 16	KB4A50101460CS03301				✓	✓			
rolltainer® 1650 FV with one pivotable front panel 4-sided ▶ in the catalogue on page 17	KB4A50101650CS04301				✓	✓			
rolltainer® 1460 FV 2-sided ▶ in the catalogue on page 16	MB2AC1460CS03101	✓	✓	✓	(✓)	(✓)			
rolltainer® 1650 FV 2-sided ▶ in the catalogue on page 17	MB2AC1650CS04101	✓	✓	✓	(✓)	(✓)			
rolltainer® 1460 FV 3-sided ▶ in the catalogue on page 16	MB3AC1460CS03101		✓	✓	(✓)	(✓)			
rolltainer® 1650 FV 3-sided ▶ in the catalogue on page 17	MB3AC1650CS04101		✓	✓	(✓)	(✓)			
rolltainer® 1460 FV with one foldable front panel 4-sided ▶ in the catalogue on page 16	MB4AC1460CS03101				✓	✓			
rolltainer® 1650 FV with one foldable front panel 4-sided ▶ in the catalogue on page 17	MB4AC1650CS04101				✓	✓			
rolltainer® 1650 FV with two pivotable front panels 4-sided ▶ in catalogue on page 17	MB4AC1650CS04201				✓	✓			
rolltainer® 1460 FV 2-sided ▶ in the catalogue on page 16	HB2AN1460CS03101				✓	✓			
rolltainer® 1650 FV 2-sided ▶ in the catalogue on page 17	HB2AN1650CS04101				✓	✓			
rolltainer® 1460 FV 3-sided ▶ in the catalogue on page 16	HB3AN1460CS03101	✓	✓	✓	(✓)	(✓)			
rolltainer® 1650 FV 3-sided ▶ in the catalogue on page 17	HB2AN1650CS04101	✓	✓	✓	(✓)	(✓)			
rolltainer® 1460 FV 3-sided ▶ in the catalogue on page 16	HB3AN1460CS03101		✓	✓	(✓)	(✓)			
rolltainer® 1650 FV 3-sided ▶ in the catalogue on page 17	HB3AN1650CS04101		✓	✓	(✓)	(✓)			

- ✓ suitable combination
- (✓) suitable combination with restrictions

rolltainer® intermediate shelves

assignment of loose intermediate shelves in the rolltainer®		intermediate shelf 716 x 812 (RB 2-sided 724)	intermediate shelf 716 x 762 (RB2- 3-sided 724)	intermediate shelf 716x 762 (2- 3 sided 724) rec.	intermediate shelf 716 x 712 (RB 4-sided 724)	intermediate shelf 716x 762 (4- sided 724) rec.	intermediate shelf 674 x 812 (RB 2-sided 682)	intermediate shelf 674 x 762 (RB 3-sided 682)	intermediate shelf 674 x 712 (RB 4-sided 682)
		F70A02PEF33000	E70A23PEF33000	E70A23RCF39005	E70A04PEF33000	E70A04RCF39005	E70B02PEF33000	E70B03PEF33000	E70B04PEF33000
rolltainer® 1460 FV with one foldable front panel 4-sided ▶ in the catalogue on page 16	HB4AN1460CS03101				✓	✓			
rolltainer® 1650 FV with one foldable front panel 4-sided ▶ in the catalogue on page 17	HB4AN1650CS04101				✓	✓			
rolltainer® 1650 FV with two pivotable front panels 4-sided ▶ in the catalogue on page 16	HB4AN1650CS04201				✓	✓			
rolltainer® 1460 FV with one pivotable front panel 4-sided ▶ in the catalogue on page 17	HB4AN1460CS03301				✓	✓			
rolltainer® 1650 FV with one pivotable front panel 4-sided ▶ in the catalogue on page 16	HB4AN1650CS04301				✓	✓			
rolltainer® rollshelf with three intermediate shelves with 20° inclination 3-sided ▶ in catalogue on page 18	KRR3A50101600C104								
rolltainer® rollshelf with three intermediate shelves with inclination 3-sided ▶ in the catalogue on page 18	KRR3A50101600C204								
rolltainer® 682 ADB 1600 3-sided ▶ in the catalogue on page 28	KAD3B50101600COZ101								
rolltainer® 682 ADB 1600 4-sided ▶ in the catalogue on page 28	KAD4B50101600COZ101								
rolltainer® 682 ADB 1600 5-sided ▶ in the catalogue on page 28	KAD5B50101600COZ101								
rolltainer® ADB 1600 3-sided ▶ in the catalogue on page 22	KAD3A50101600COZ101								
rolltainer® ADB 1350 3-sided ▶ in the catalogue on page 21	KAD3A50101350COZ101								
rolltainer® ADB 1020 3-sided ▶ in the catalogue on page 20	KAD3A50101020COZ101								
rolltainer® ADB 1600 4-sided ▶ in the catalogue on page 22	KAD4A50101600COZ101								
rolltainer® ADB 1350 4-sided ▶ in the catalogue on page 21	KAD4A50101350COZ101								
rolltainer® ADB 1020 4-sided ▶ in the catalogue on page 20	KAD5A50101600COZ101								
rolltainer® ADB 1600 5-sided ▶ in the catalogue on page 22	KAD4A50101020COZ101								

- ✓ suitable combination
- (✓) suitable combination with restrictions

nestainer® intermediate shelves

assignment of loose intermediate shelves in the nestainer®		intermediate shelf 716 x 812 (RB 2-sided 724)	intermediate shelf 716 x 762 (RB2- 3-sided 724)	intermediate shelf 716x762 (2- 3 sided 724) rec.	intermediate shelf 716 x 712 (RB 4-sided 724)	intermediate shelf 716x 762 (4- sided 724) rec.	intermediate shelf 674 x 812 (RB 2-sided 682)
		F70A02PEF33000	E70A23PEF33000	E70A23RCF39005	E70A04PEF33000	E70A04RCF39005	F70A02PEF33000
nestainer® Ergo 1460 S 2-sided ▶ in the catalogue on page 44	N2700800CCOZ019	✓	✓	✓			
nestainer® Ergo 1460 S 3-sided ▶ in the catalogue on page 44	N3700800CCOZ019		✓	✓			
nestainer® Ergo 1460 S 4-sided ▶ in the catalogue on page 44	N4700800CCOZ019				✓	✓	
nestainer® ERGO 1460 S 2-seitig ▶ in the catalogue on page 52	N2700800CCOZ019	✓	✓	✓			
nestainer® ERGO 1460 S 3-seitig ▶ in the catalogue on page 52	N3700800CCOZ019		✓	✓			
nestainer® ERGO 1460 S 4-seitig ▶ in the catalogue on page 52	N4700800CCOZ019				✓	✓	

✓ suitable combination
(✓) suitable combination with restrictions

								intermediate shelf 674 x 762 (RB 3-sided 682)
								intermediate shelf 674 x 712 (RB 4-sided 682)
✓	✓	✓	✓	✓	✓	✓	✓	half plastic interme- diate shelf made of E70A23PEF3
✓	✓	✓	✓	✓	✓	✓	✓	half plastic inter- mediate shelf made of rec.
								intermediate shelf 716 x 812 closed version 2-sided
								intermediate shelf 716 x 762 closed version 3-sided
								intermediate shelf 716 x 812 closed version 2-sided stainl. steel FE
								intermediate shelf 716 x 762 closed version 3-sided stainl. steel FE
✓	✓	✓	✓	✓	✓	✓	✓	intermediate shelf for ADB with 3 flat bars without cutout
✓	✓	✓	✓	✓	✓	✓	✓	intermediate shelf steel (RB 2/3/4/5-sided 724)
✓	✓	✓	✓	✓	✓	✓	✓	intermediate shelf wood (RB 2/3/4/5-si- ded 724)
								intermediate shelf 712 x 808 (RB comfort system)

rolltainer® spare parts

		side panel		back panel		1 piece foldable
catalogue page	rolltainer article	article name	article number	article name	article number	article name
page 13	rolltainer 1350 QP	side panel 1350 powder coated, blue similar to RAL 5010	SG1350790S0015010	back panel 1340 powder coated, blue similar to RAL 5010	RW1340650R0015010	
	rolltainer 1350 QP	side panel 1350 powder coated, green similar to RAL 6024	SG1350790S0016024	back panel 1340 powder coated, green similar to RAL 6024	RW1340650R0016024	
	rolltainer 1350 QP	side panel 1350 powder coated, red similar to RAL 3000	SG1350790S0013000	back panel 1340 powder coated, red similar to RAL 3000	RW1340650R0013000	
page 13	rolltainer 1450 QP	side panel 1450 powder coated, blue similar to RAL 5010	SG1450790S0025010	back panel 1440 powder coated, blue similar to RAL 5010	RW1440650R0025010	
	rolltainer 1450 QP	side panel 1450 powder coated, green similar to RAL 6024	SG1450790S0026024	back panel 1440 powder coated, green similar to RAL 6024	RW1440650R0026024	
	rolltainer 1450 QP	side panel 1450 powder coated, red similar to RAL 3000	SG1450790S0023000	back panel 1440 powder coated, red similar to RAL 3000	RW1440650R0023000	
page 15	rolltainer 1350 QV	side panel 1350, Cr3	SG1350790S001C	back panel 1340, Cr3	RW1340650R001C	
	rolltainer 1450 QV	side panel 1450, Cr3	SG1450790S002C	back panel 1440, Cr3	RW1440650R002C	
	rolltainer 1650 QV	side panel 1650, Cr3	SG1650790S104C	back panel 1640, Cr3	RW1640650R004C	
page 16	rolltainer 1460 FV	side panel 1460, Cr3	SG1460790S003C	back panel 1450, Cr3	RW1450650R003C	front panel 1440 foldable and pivotable, Cr3
page 17	rolltainer 1650 FV	side panel 1650, Cr3	SG1650790S004C	back panel 1640, Cr3	RW1640650R004C	front panel 1640 foldable and pivotable, Cr3
page 18	rollshelf	side panel rollshelf right, 20° inclination	SG1600702RR01C	back panel rollshelf, Cr3	RW1610735RR01C	
		side panel rollshelf left, 20° inclination	SG1600702RL01C			
page 20	rolltainer ADB 1020	side panel ADB 1020 right, Cr3	ADB1020SGREC04	back panel ADB 1020, Cr3	ADB1020RWC04	
		side panel ADB 1020 left, Cr3	ADB1020SGLIC04			
page 21	rolltainer ADB 1350	side panel ADB 1350 right, Cr3	ADB1350SGREC04	back panel ADB 1350, Cr3	ADB1350RWC04	
		side panel ADB 1350 left, Cr3	ADB1350SGLIC04			
page 22	rolltainer ADB 1600	side panel ADB 1600 right, Cr3	ADB1600SGREC04	back panel ADB 1600, Cr3	ADB1600RWC04	
		side panel ADB 1600 left, Cr3	ADB1600SGLIC04			
page 23	rolltainer ADB 1600	side panel ADB 1600 right, Cr3	ADB1600SGREC15	back panel ADB 1600, Cr3	ADB1600RWC04	
		side panel ADB 1600 left, Cr3	ADB1600SGLIC15			

- ✓ suitable combination
- (✓) suitable combination with restrictions

front panel					roof	
and pivotable	2-part pivotable		1 piece pivotable			
article number	article name	article number	article name	article number	article name	article number
			front panel 1350 one piece, Cr3	VW1305650F801C		
			front panel 1450 one piece, Cr3	VW1305650F801C		
			front panel 1650 one piece, Cr3	VW1640650F204C		
VW1440650F103C			front panel 1440 one piece, Cr3	VW1440650F203C		
VW1640650F104C	front panel 1640 2-part pivotable, Cr3	VW1640650F304C	front panel 1640 one piece, Cr3	VW1640650F204C		
			door ADB 1020 one piece, Cr3	ADB1020TÜC04	roof ADB 1020, Cr3	ADB1600DAC04
			door ADB 1350 one piece, Cr3	ADB1350TÜC04	roof ADB 1350, Cr3	ADB1600DAC04
			door ADB 1600 one piece, Cr3	ADB1600TÜC04	roof ADB 1600, Cr3	ADB1600DAC04
	door ADB 1600 oben, Cr3	ADB1600TÜOTC15			roof ADB 1600, Cr3	ADB1600DAC04
	door ADB 1600 unten, Cr3	ADB1600TÜUTC15				

rolltainer® spare parts

		side panel		back panel		1 piece foldable
catalogue page	rolltainer article	article name	article number	article name	article number	article name
page 25	ADB 1600 special application	on request		on request		
page 24	rolltainer ADB 1600 "the disposer"	side panel ADB 1600 right, Cr3	ADB1600SGREC16	back panel ADB 1600, Cr3	ADB1600RWC16	
		side panel ADB 1600 left, Cr3	ADB1600SGLIC16			
page 26	rolltainer 682 1460	side panel 1460, Cr3	SG1460790S003C	back panel 1450, Cr3	RW1450667R003C	
	rolltainer 682 1650	side panel 1650, Cr3	SG1650790S004C	back panel 1640, Cr3	RW1640667R004C	
page 28	rolltainer 682 ADB 1600	side panel ADB 1600 right, Cr3	ADB1600SGREC08	back panel ADB 1600, Cr3	ADB1600RWC08	
		side panel ADB 1600 left, Cr3	ADB1600SGLIC08			
page 29	rolltainer 682 1500 F	side panel 1500 hot-dipped	SG1500790S000HD	back panel 1440 hot-dipped	RW1440620R000HD	front panel 1448 foldable, hot-dipped
page 44	rolltainer BASIC	side panel 1350, Cr3	SG1350790S0C8C	back panel 1340, Cr3	RW1340704R0C8C	front panel 1292 foldable and pivotable, Cr3
page 46	rolltainer ADB Basic	side panel ADB 1600 right, Cr3	ADB1600SGREC	back panel ADB 1600, Cr3	ADB1600RWC	
		side panel ADB 1600 left, Cr3	ADB1600SGLIC			

spare parts	
plastic clamp for ø 22 mm round tube incl. mounting material	SETK01
plastic hinge for ø 22 mm round tube incl. mounting material	SETK02
plastic hinge inclined ø 22er tube incl. screw and nut	SETK03
plastic clamp ø 20er tube incl. screw and nut	SETK04
plastic hinge ø 20er tube incl. screw M8	SETK05

- ✓ suitable combination
- (✓) suitable combination with restrictions

front panel					roof	
and pivotable	2-part pivotable		1 piece pivotable			
article number	article name	article number	article name	article number	article name	article number
			on request		on request	
	door ADB 1600 oben, Cr3	ADB1600TÜOTC16				
	door ADB 1600 unten, Cr3	ADB1600TÜUTC16				
			door ADB 1600 one piece, Cr3	ADB1600TÜC08	roof ADB 1600 Cr3	ADB1600DAC08
VW1448620F000HD						
VW1292686F0C8C			front panel 1280 one piece, Cr3	VW1280686F1C8C		
			door ADB 1600 one piece, Cr3	ADB1600TÜC	roof ADB 1600 Cr3	ADB1600DAC

Our products at a glance

rolltainer®

Accessories – intermediate shelf	38
Base	9
Base BASIC	45
Base with push handle	33
Plastic base special	34
rolltainer® 1350 / 1450	13
rolltainer® 1350 / 1450 / 1650	14
rolltainer® 1460	16
rolltainer® 1650	17
rolltainer® 675 1460 / 1650	30
rolltainer® 682 1350	27
rolltainer® 682 1460 / 1650	26
rolltainer® 682 1500 FH	29
rolltainer® 682 ADB 1600	28
rolltainer® 1590 KU	35
rolltainer® ADB 1020	20
rolltainer® ADB 1350	21
rolltainer® ADB 1600	22
rolltainer® ADB 1600 with foldable intermediate shelf	23
rolltainer® ADB 1600 “the disposer”	24
rolltainer® ADB BASIC	46
rolltainer® ADB special applications	25
rolltainer® BASIC	44
rolltainer® hygienic stainless steel	31
rolltainer® rollshelf 1600	18
rolltainer® Special	32
rolltainer® with comfort system	40
rolltainer® with double clamping	37
rolltainer® with plug-in system	6

nestainer®

nestainer® 1450	54
nestainer® 1630	55
nestainer® ADB 1450	56
nestainer® ADB 1600 ME, 800 x 1200 mm	58
nestainer® ADB 1600	57
nestainer® ERGO 1460 K	50
nestainer® ERGO 1460 S	52
nestainer® ERGO 1570 S „light“	53
nestainer® ERGO Fold	60
nestainer® with pendulum rod	61

nestainer®-L KU 800 x 1100 mm	59
-------------------------------	----

Steel roll containers

Ball cart , 610 x 1040 mm	72
Mesh stacking frame VZ on steel base	83
Steel roll container 1600, 950 x 1350 mm	68
Steel roll container 1490, 600 x 600 mm	65
Steel roll container 1600, 800 x 1200 mm	66
Steel roll container 1600, 800 x 1200 mm	76
Steel roll container 1600, 800 x 1600 mm	69
Steel roll container 1650, 600 x 800 mm	73
Steel roll container 1665, 460 x 640 mm	64
Steel roll container 620 x 1500 mm	70
Steel roll container ADB 1600, 800 x 1200 mm	74
Picking cart L	80
Picking cart M	78
Picking cart S	77
Picking cart XL	82

Laundry containers

Accessories – Laundry containers	98
Laundry containers 600 x 720 mm	87
Laundry containers 600 x 740 mm	88
Laundry containers 600 x 810 mm	89
Laundry containers 710 x 810 mm	96
Laundry containers 720 x 810 mm	90
Laundry containers 825 x 738 mm	94
Laundry containers 875 x 650 mm	86
Laundry containers 875 x 675 mm	95
Laundry containers 1185 x 503 mm	97
Laundry containers 1590 / 1600	92
Laundry containers 1600	93

rolldolly®

Adapter pallet INDUSTRY 1200 x 800 mm	121
Drawbar and coupling set	123
Furniture Dolly	118
Lid KU	119
Pallet carrier and stacking frame	122
rolldolly® ALU	114

rolldolly® BASIC	125
rolldolly® CLASSIC & FAVORIT	109
rolldolly® FLEX	112
rolldolly® INDUSTRY chassis 400 x 600 mm	120
rolldolly® LIGHT	108
rolldolly® STAINLESS STEEL	116
rolldolly® STEEL	117
rolldolly® Tower ME 1035	115
rolldolly® XL CLASSIC & FAVORIT	110

Cargo systems

Angle frame for pallets and pallet cages	137
Big Boxes	142
Buckets and bins	149
Disposal container on wooden or plastic pallet	132
Europallet and europallet roller	128
Insulated Container	138
Mesh stacking frame PB	129
Mesh stacking frame VZ	130
PalletEdge and PalletStack Pro	135
Plastic pallets	146
SteelBox Basic and SteelBox Pro	136
Wire mesh container ME	131
Wooden stacking frame	134

Special applications

EasyGo One	156
EasyGo Premium Medium	156
S-Dozer	157
Translet Walker	175

Wheels and castors

AAB5 alu / polyurethane brown ø 100 mm / ø 125 mm	170
AAE2 alu / elastic grey ø 100 mm / ø 125 mm	169
AAU5 alu / polyurethane brown ø 100 mm / ø 125 mm	169
M6N2 polyamide sandwich ø 100 mm / ø 125 mm	167
N0N0 polyamide white (V2A) ø 100 mm / ø 125 mm	171
N0N0 polyamide white ø 100 mm / ø 125 mm	165
N0N0 polyamide white ø 108 mm	164

N2U6 polyamide / polyurethane red (V2A) ø 100 / 125 mm	171
N2U6 polyamide / polyurethane red ø 100 mm / ø 125 mm	167
N4B5 polyamide / polyurethane brown ø 100 mm / ø 125 mm	170
P0P0 polypropylene white ø 100 mm / ø 125 mm	165
P0P0 polypropylene white ø 108 mm	164
P2G2 polypropylene / thermopl. rubber ø 100 mm / ø 125 mm	168
P2W2 polypropylene / thermopl. rubber ø 100 mm	168
R4E1 polyamide / elastic blue ø 100 mm / ø 125 mm	166
R4E2 polyamide /elastic grey ø 100 mm / ø 125 mm	166

Accessories

Back panel frame ME	182
Clothes rail ME	182
Document holder KU for rolltainer®	182
Drawbar and coupling set, Cr 3	184
Foil compactor, Cr 3	184
Forklift entry lugs for roll container	184
gummitex®	185
Handle set for steel roll container with ø 22 mm round tube	181
Handle set for steel roll container with square tube 22 mm	181
One-way cover for rolltainer® 724 x 815 mm	178
Picking board with clip board, Cr 3	183
Protective covers	178
Rubber strap	185
Securing grid for rolltainer®	174
Sheet metal board for rolltainer® side panel	183
Sheet metal board with laser writing, Cr 3, retrofittable	183
tainergrip® for permanent installation	180
tainerlift for rolltainer®	177
tainergrip® for side panel with flat bars	180
tainergrip® for side panels with lateral tube	180
Textile strap	185
Thermal cover for rolltainer® 724 x 815 mm	179

The information in this catalogue were compiled and examined carefully. However, errors and misprints, principally technical changes through further development and improvement of our products, excepted.

Pictures and illustrations are sometimes only similar or else exemplary and show possible options. Shown equipment and features are not necessarily included in the delivery scope.

The partial reprint or the duplication of the catalogue is only permitted with the explicit, written permission of FEIL rolltainer GmbH. All information in this catalogue, texts, illustrations, documents and descriptions are subject to copyright and to the proprietary notice restricting the

utilization of documents and products according to DIN ISO 16016.

All rights reserved.

© Copyright FEIL rolltainer GmbH 2026



Home of Material Handling

Hankerfeld 8
59602 R then
Germany

+49 02952 970958-0

info@hmh.eu
www.hmh.eu